

CAMBRIDGE

GREENMAN & THE MAGIC FOREST

A

Marilyn Miller

Teacher's Resource Book

Karen Elliott



Contents

Unit 1 Four Rabbits

- Photocopiable 1 - Language
- Photocopiable 2 - Value
- Photocopiable 3 - Skills
- Photocopiable 4 - Phonics

Unit 2 The Honey Game

- Photocopiable 5 - Language
- Photocopiable 6 - Value
- Photocopiable 7 - Skills
- Photocopiable 8 - Phonics

Review 1 - Autumn Fun

- Photocopiables 9 and 10 - Autumn project

Unit 3 I'm Hurt

- Photocopiable 11 - Language
- Photocopiable 12 - Value
- Photocopiable 13 - Skills
- Photocopiable 14 - Phonics

Unit 4 It's Too Small

- Photocopiable 15 - Language
- Photocopiable 16 - Value
- Photocopiable 17 - Skills
- Photocopiable 18 - Phonics

Review 2 - Winter Fun

- Photocopiables 19 and 20 - Winter project

Unit 5 Can I Help You?

- Photocopiable 21 - Language
- Photocopiable 22 - Value
- Photocopiable 23 - Skills
- Photocopiable 24 - Phonics

Unit 6 The Summer Party

- Photocopiable 25 - Language
- Photocopiable 26 - Value
- Photocopiable 27 - Skills
- Photocopiable 28 - Phonics

Review 3 - Spring Fun

- Photocopiables 29 and 30 - Spring project

Review 4 - Summer Fun

- Photocopiables 31 and 32 - Summer project

Diploma

- Photocopiable 33

Festival 1 - Halloween

- Photocopiable 34 - Halloween project
- Photocopiable 35 - Phonics

Festival 2 - Christmas

- Photocopiable 36 - Christmas project
- Photocopiable 37 - Phonics

Festival 3 - Easter

- Photocopiable 38 - Easter project
- Photocopiable 39 - Phonics

Festival 4 - Green Day

- Photocopiable 40 - Green Day project
- Photocopiable 41 - Phonics

Characters

- Photocopiable 42 - Greenman
- Photocopiable 43 - Nico
- Photocopiable 44 - Sam

1 Four Rabbits

Follow the sequence and draw.

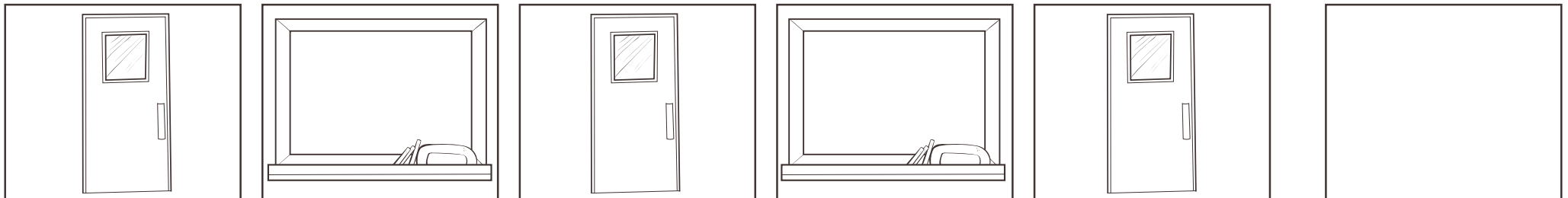
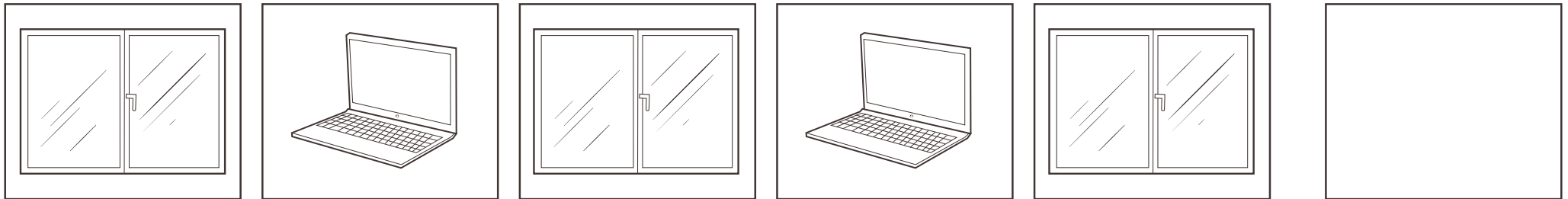
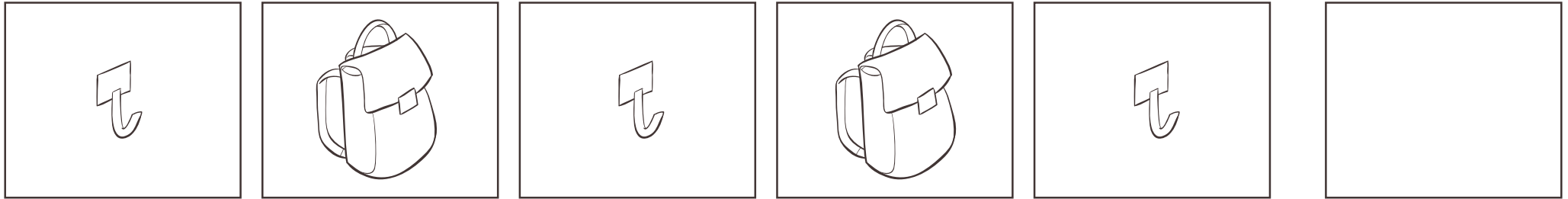

■ There are (pegs). / There aren't (doors). (board, computer, window, bag)

Trace and colour.



Finish the pictures.

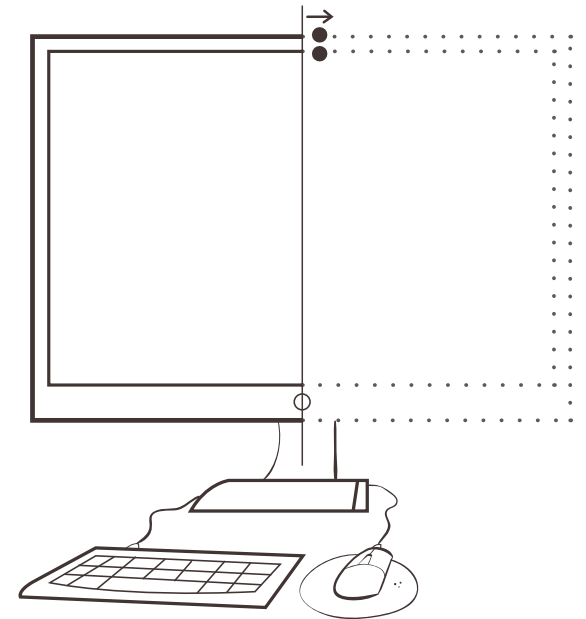
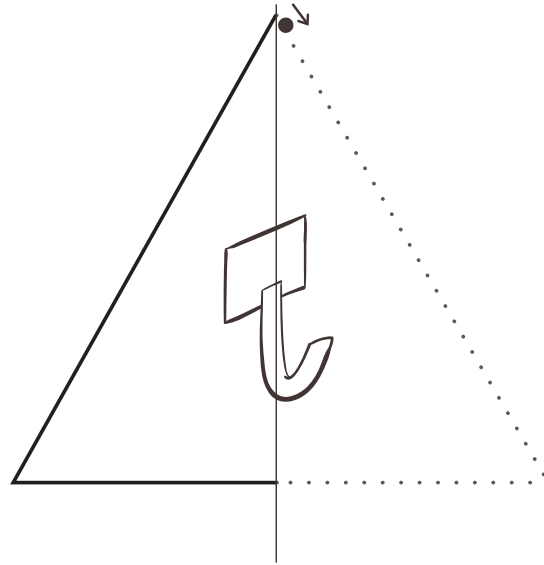
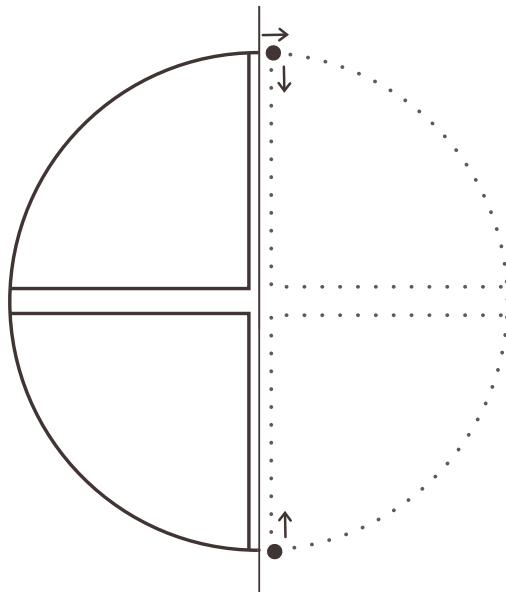
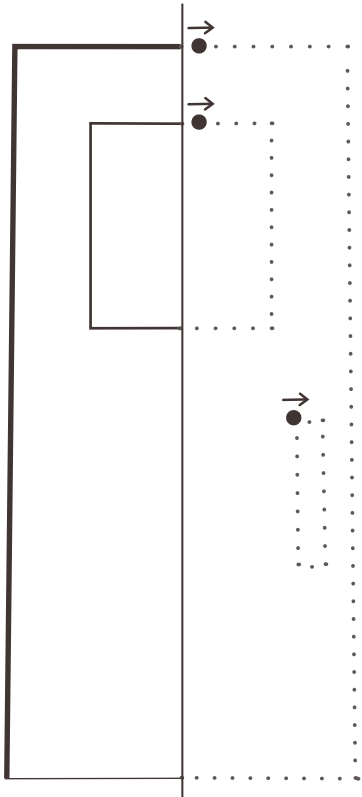



Trace and colour the ants black and the eggs red.

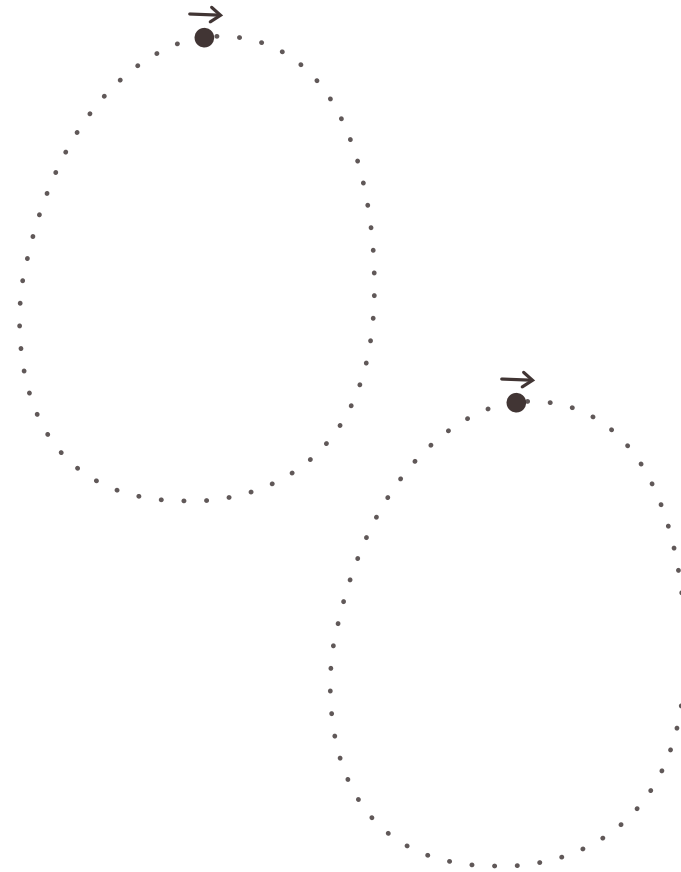
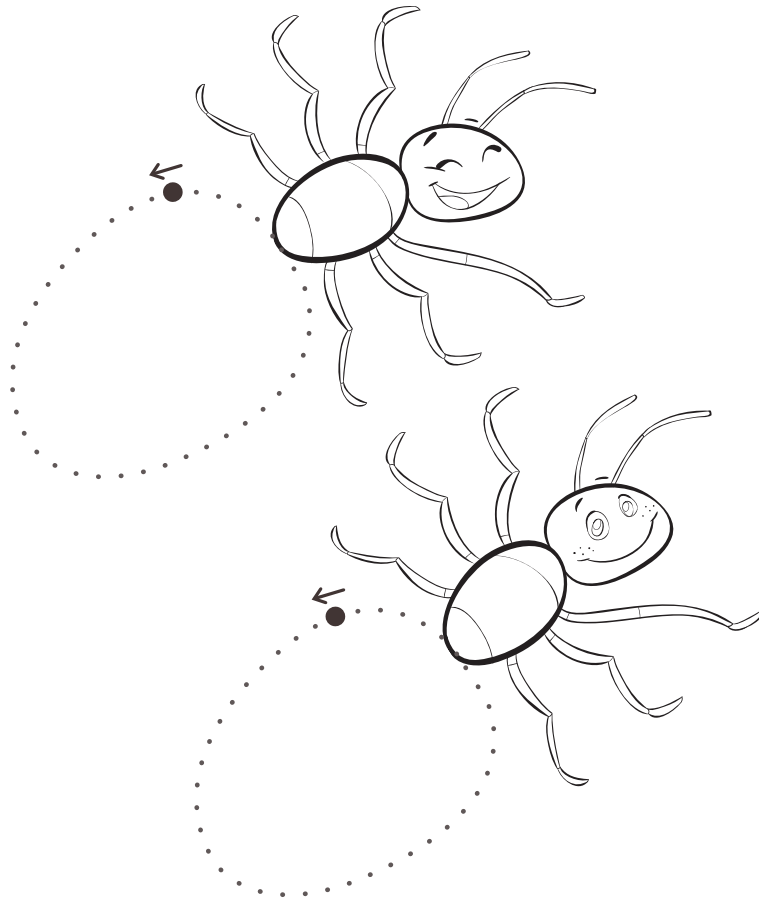

ants

eggs

2 The Honey Game

Look and match.

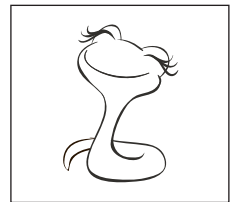
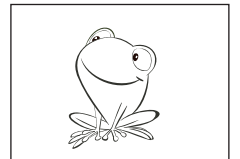
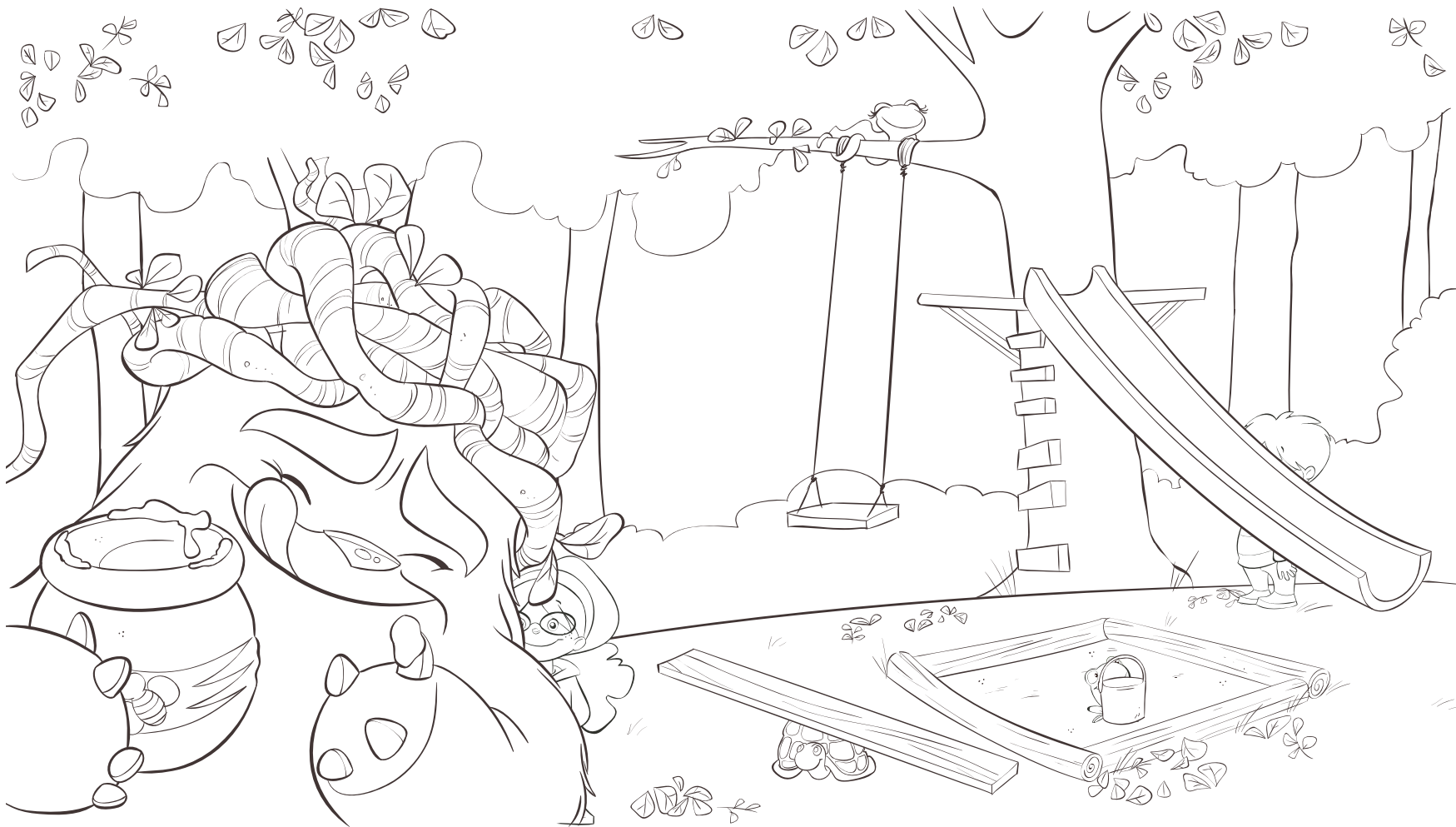

Where's (Sam)? / Let's play on the (swing). (slide, seesaw, sandpit, bucket, spade)

Trace the honey trail.

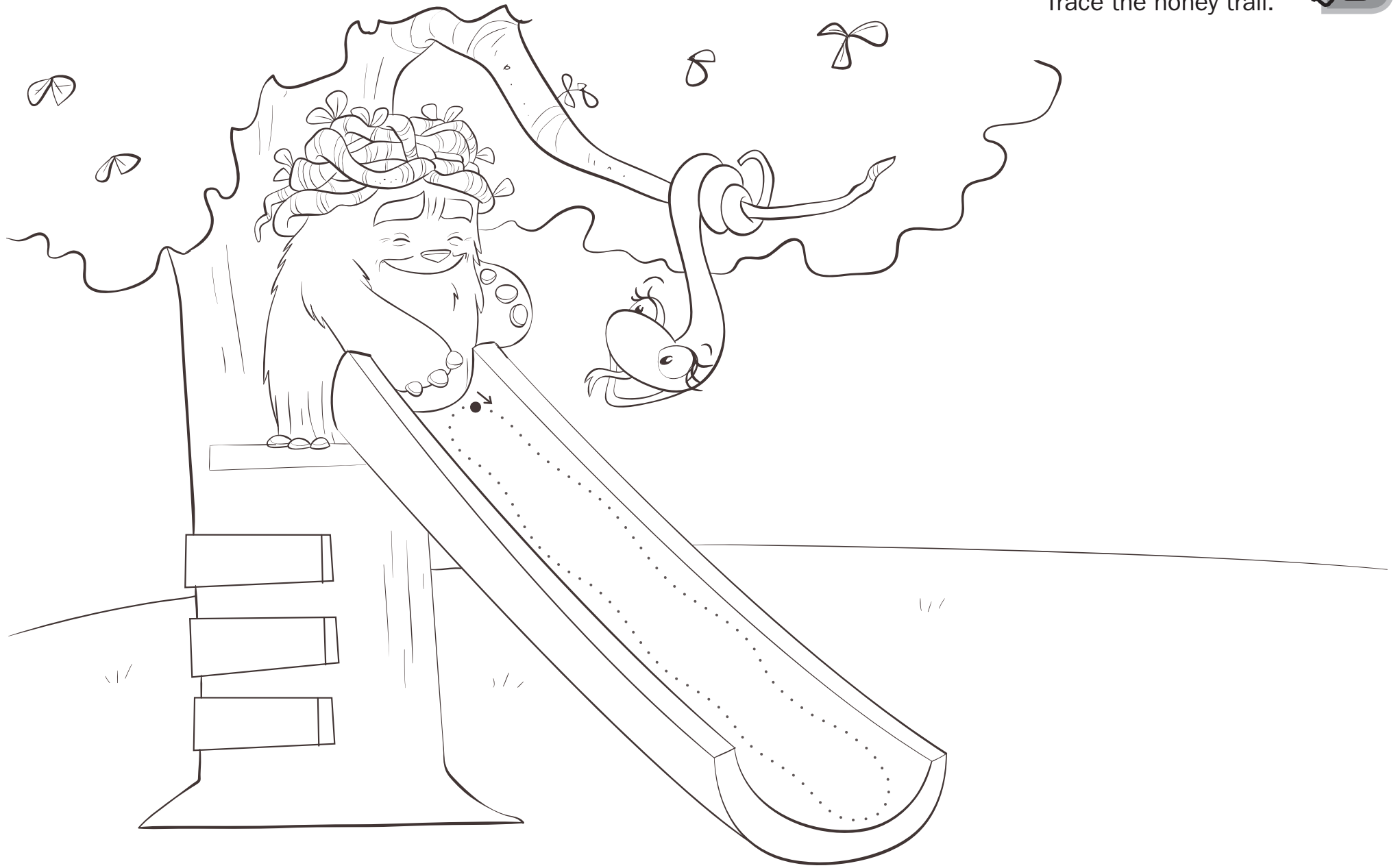

Help Greenman find the honey.

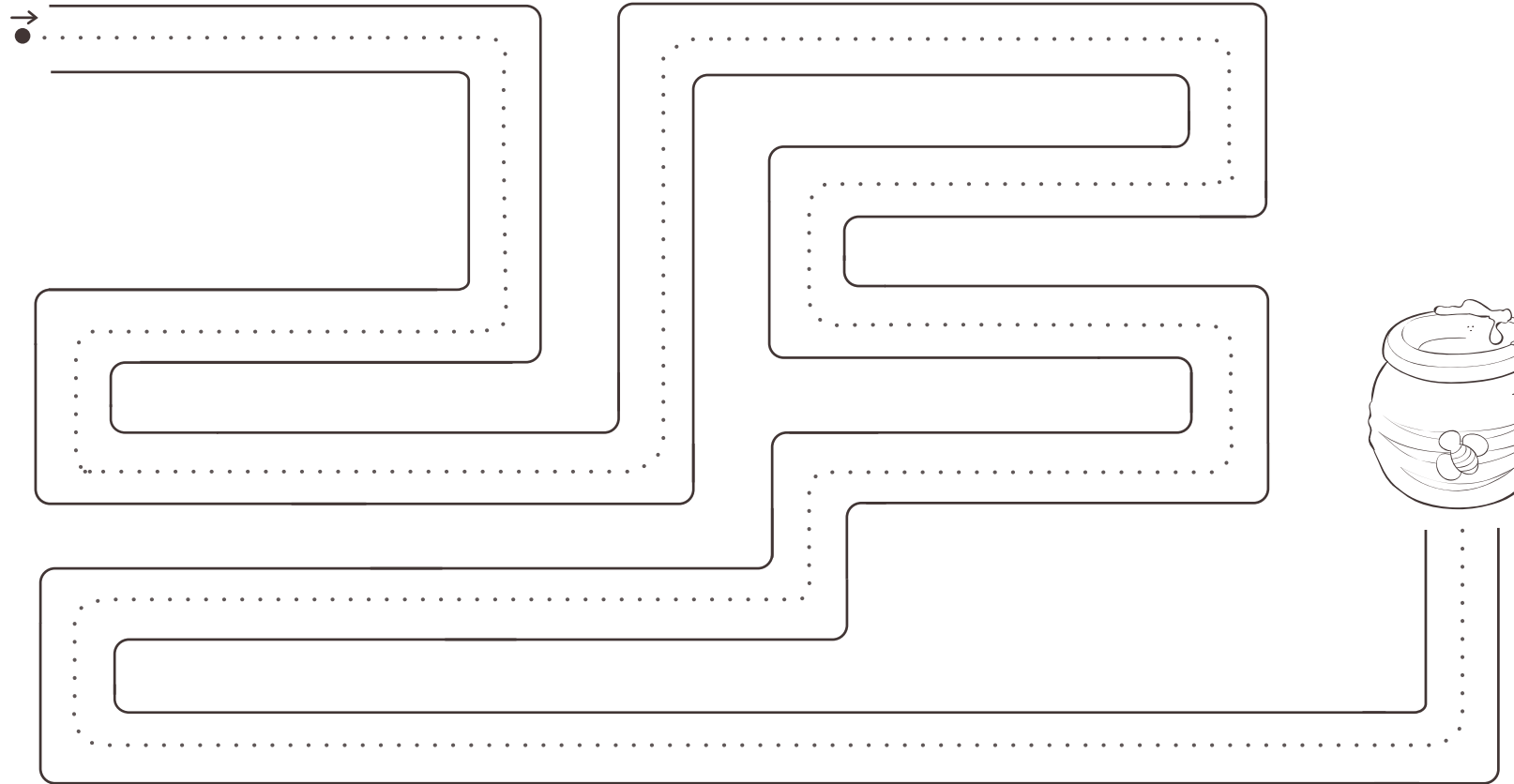



Trace and cut out the insect and the orange.

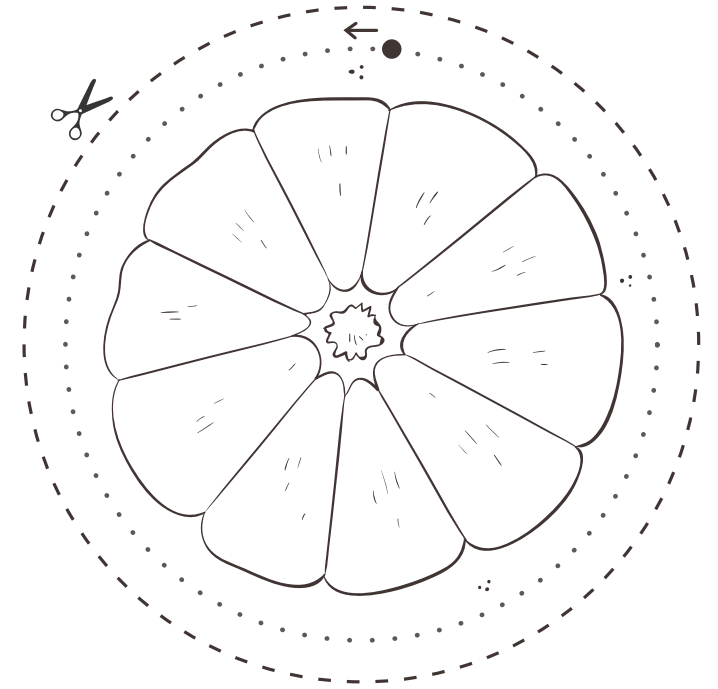
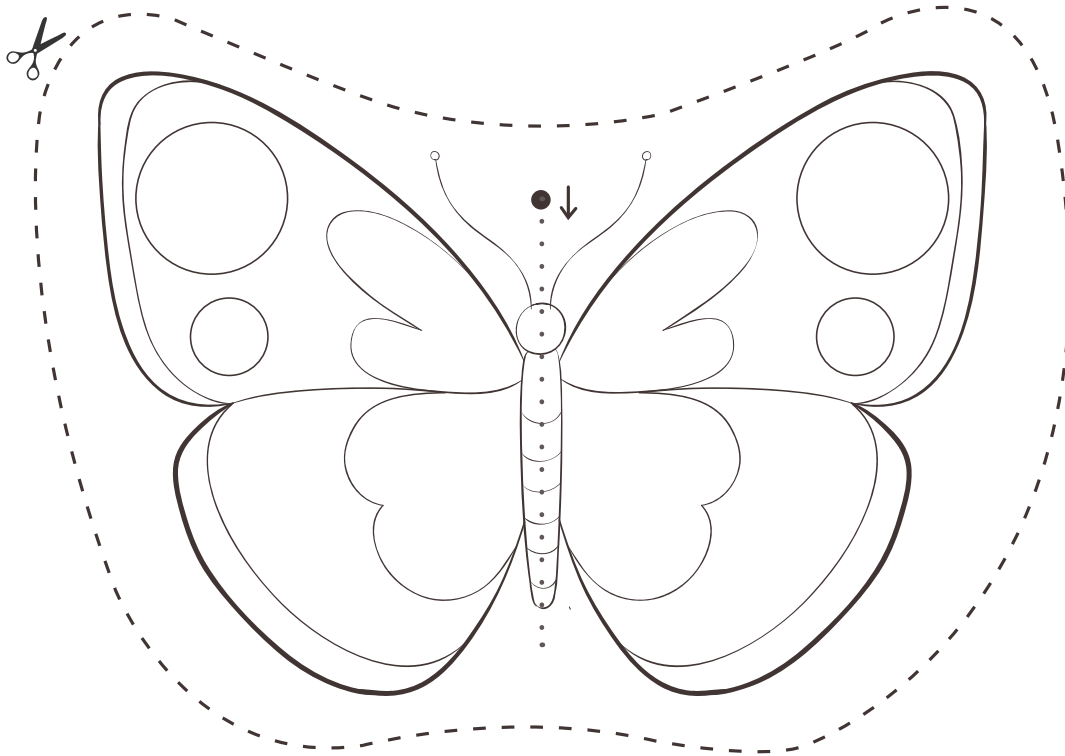

Autumn Fun!

Autumn project: Paint, cut and stick to make a tree.

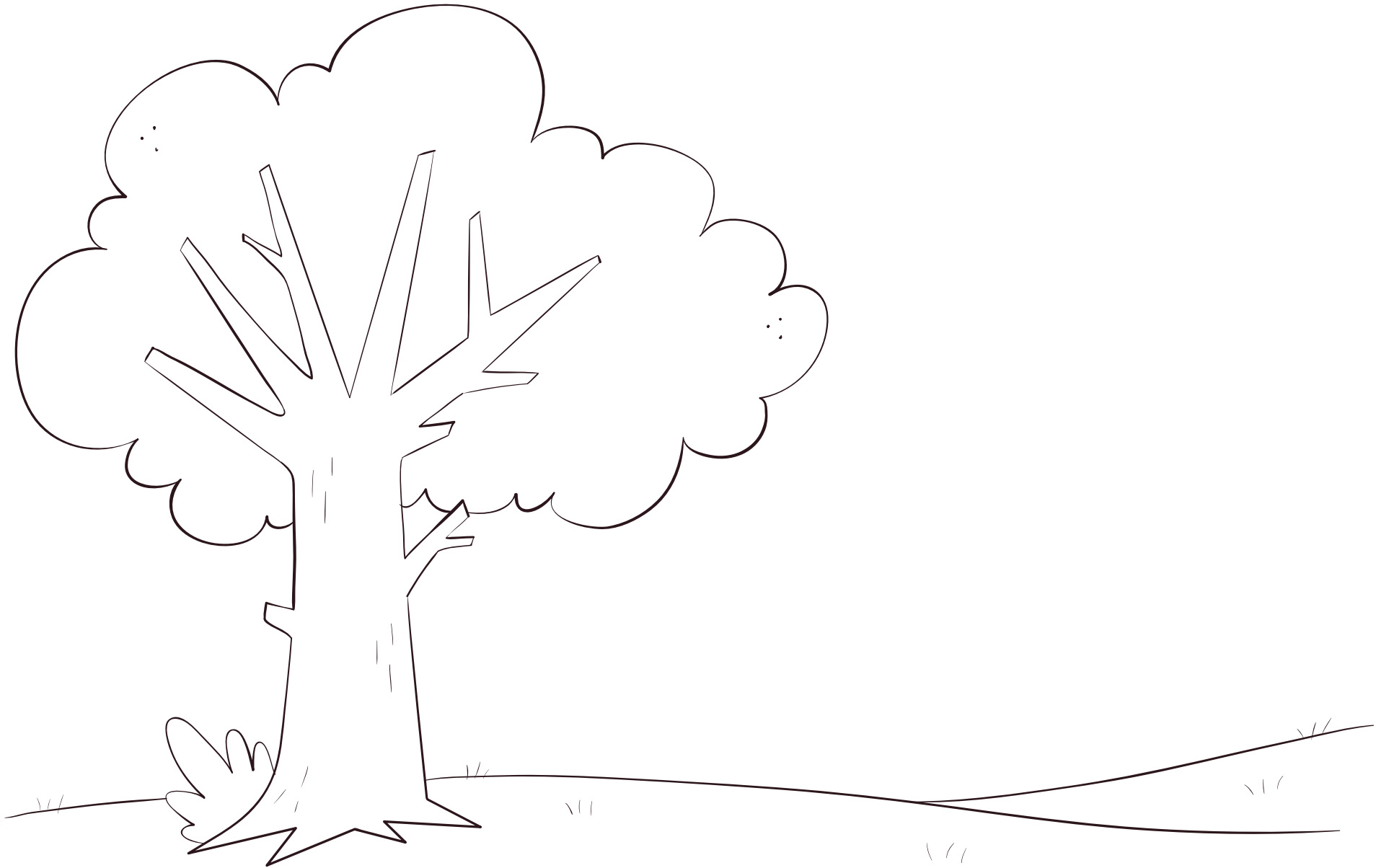

red, brown, windy, rainy

Autumn project: Paint, cut and stick to make a tree.

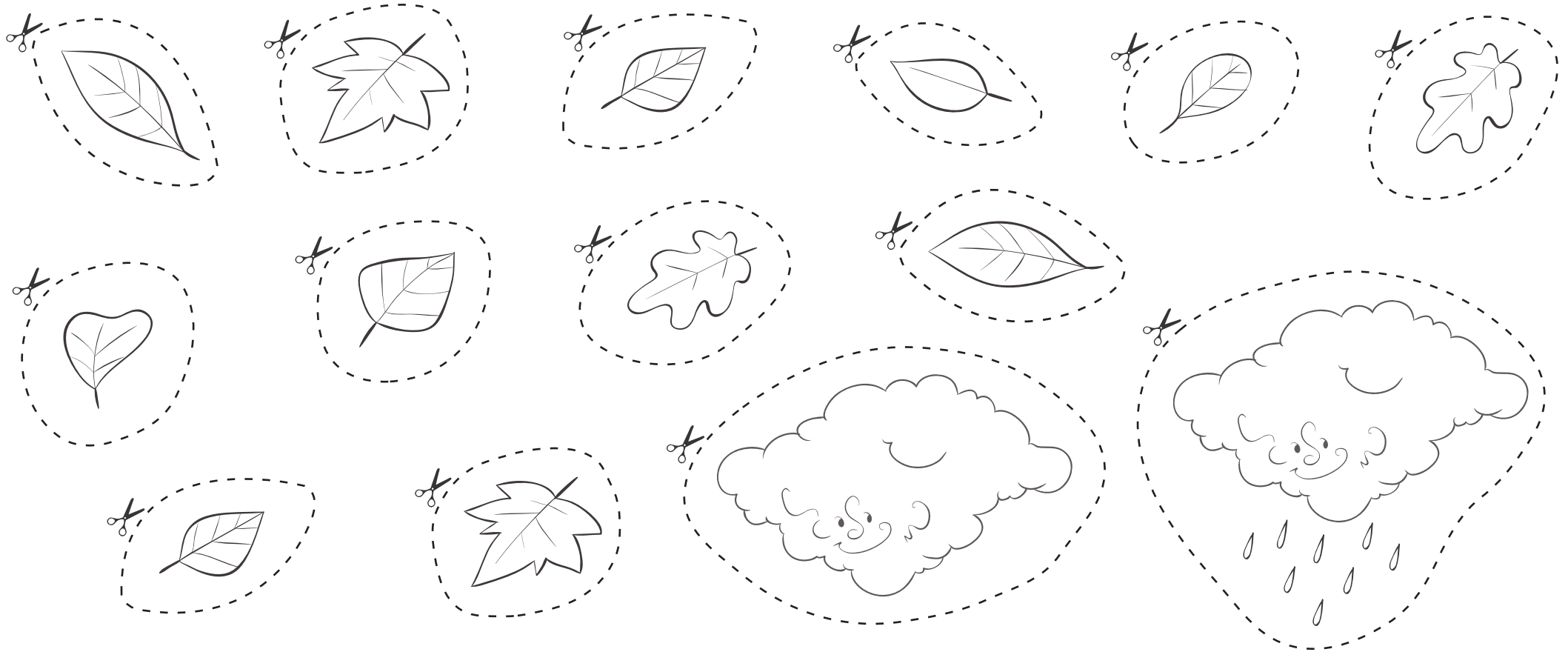

3 I'm Hurt

Cut and stick.

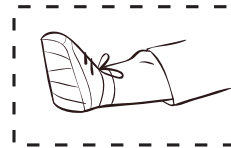
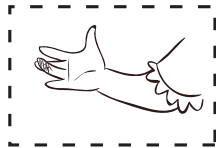
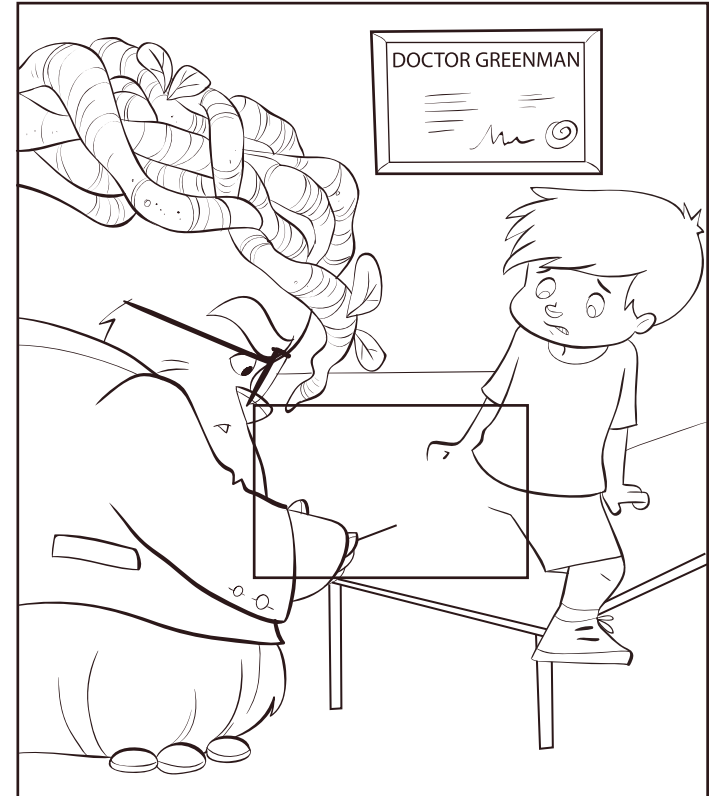
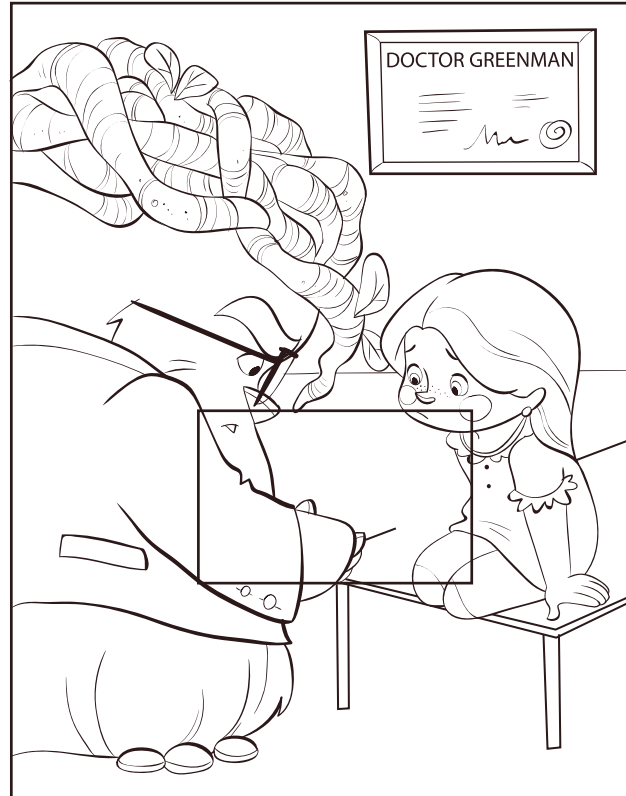

Look and circle.

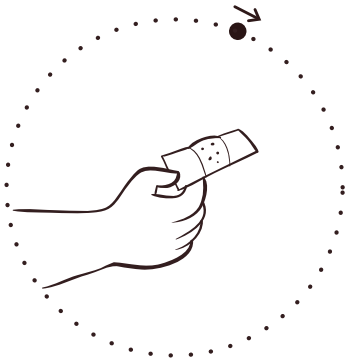
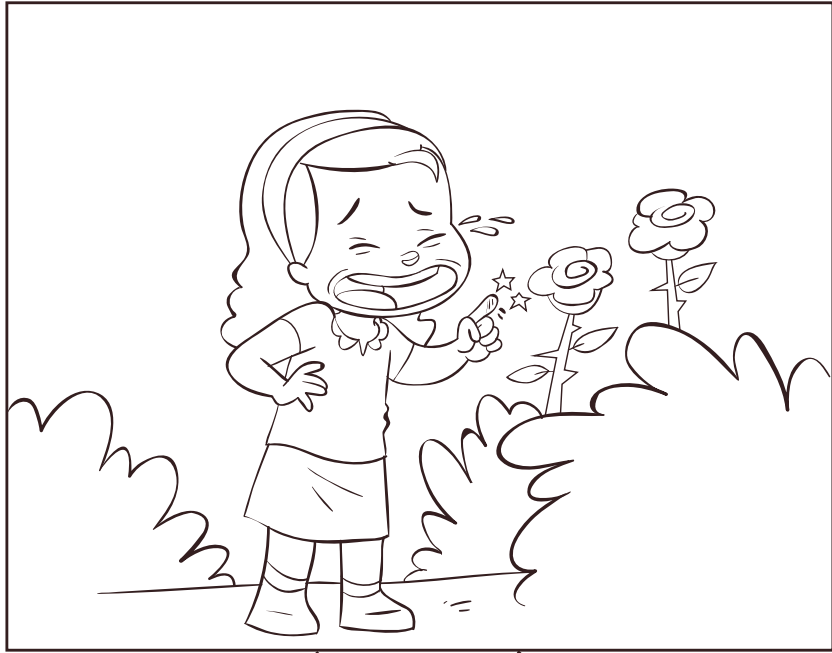



Trace your hand.





Trace the spider's legs. Colour and trace the flower.

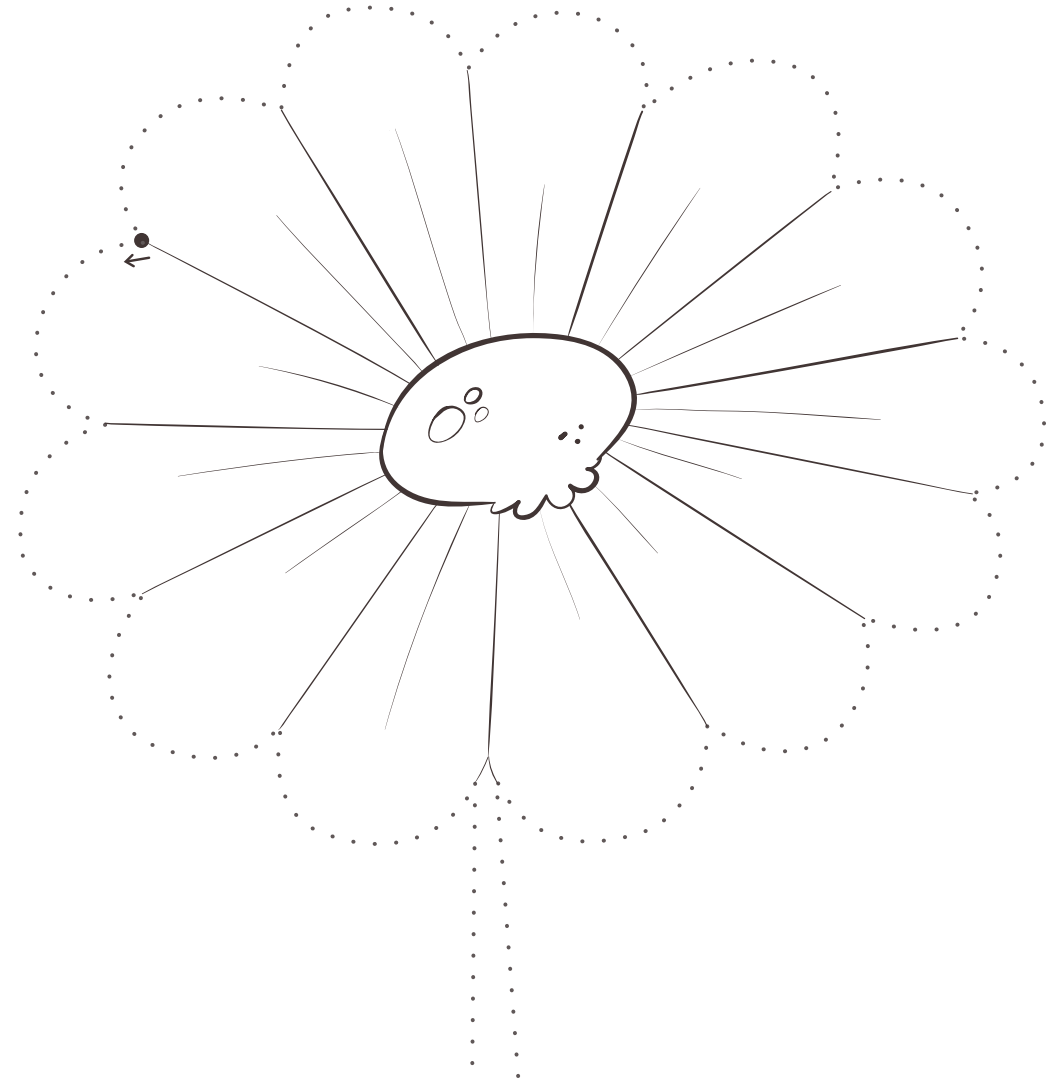
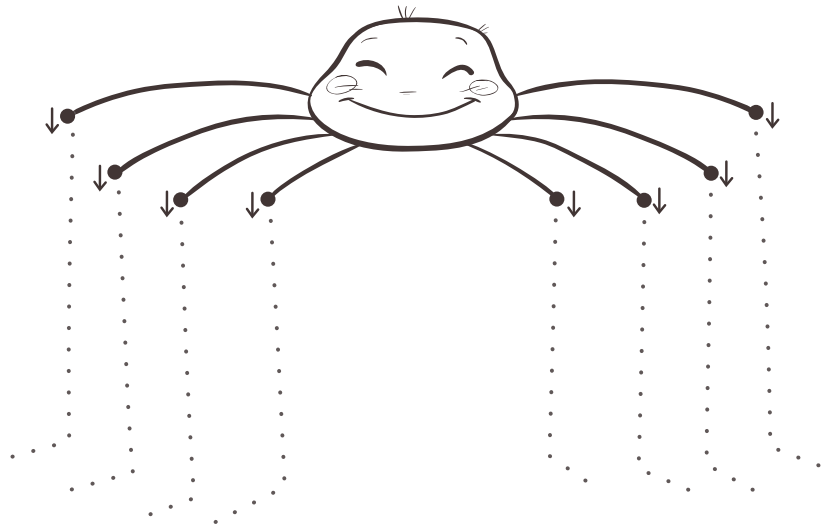

4 It's Too Small

Finish the pictures.

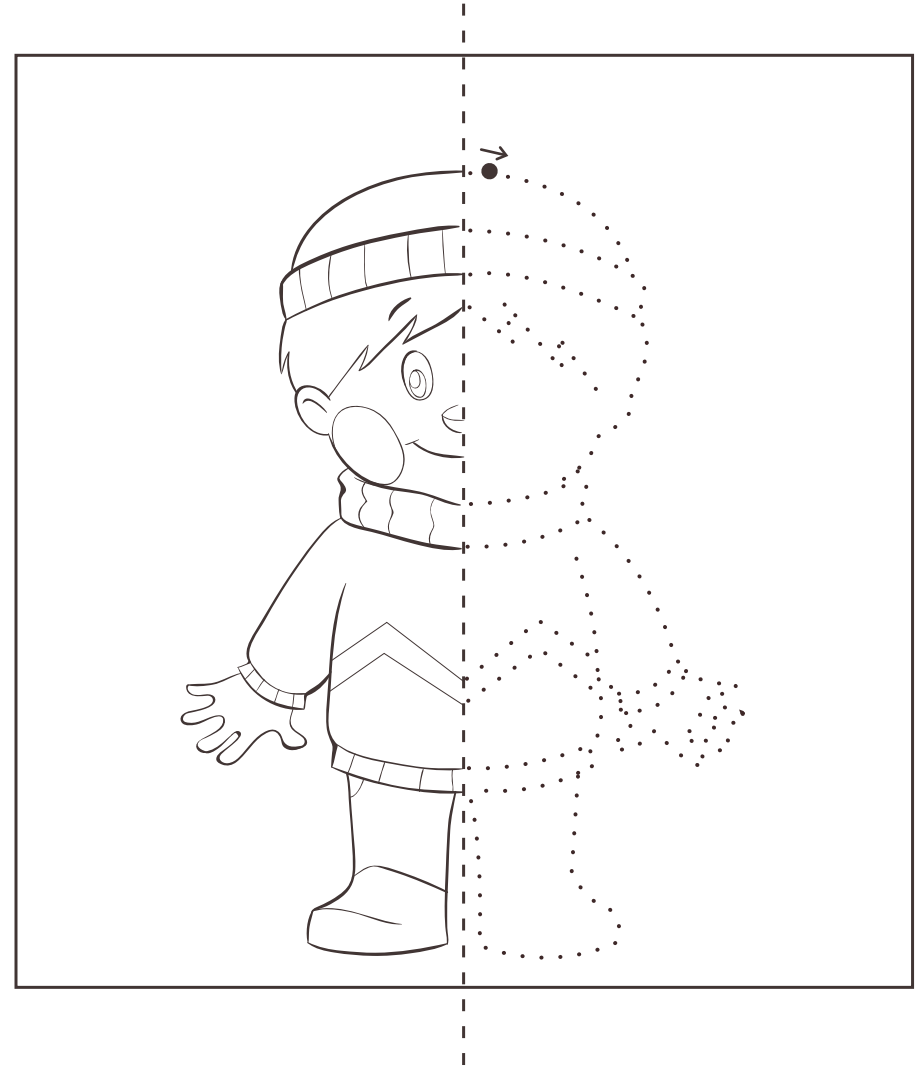
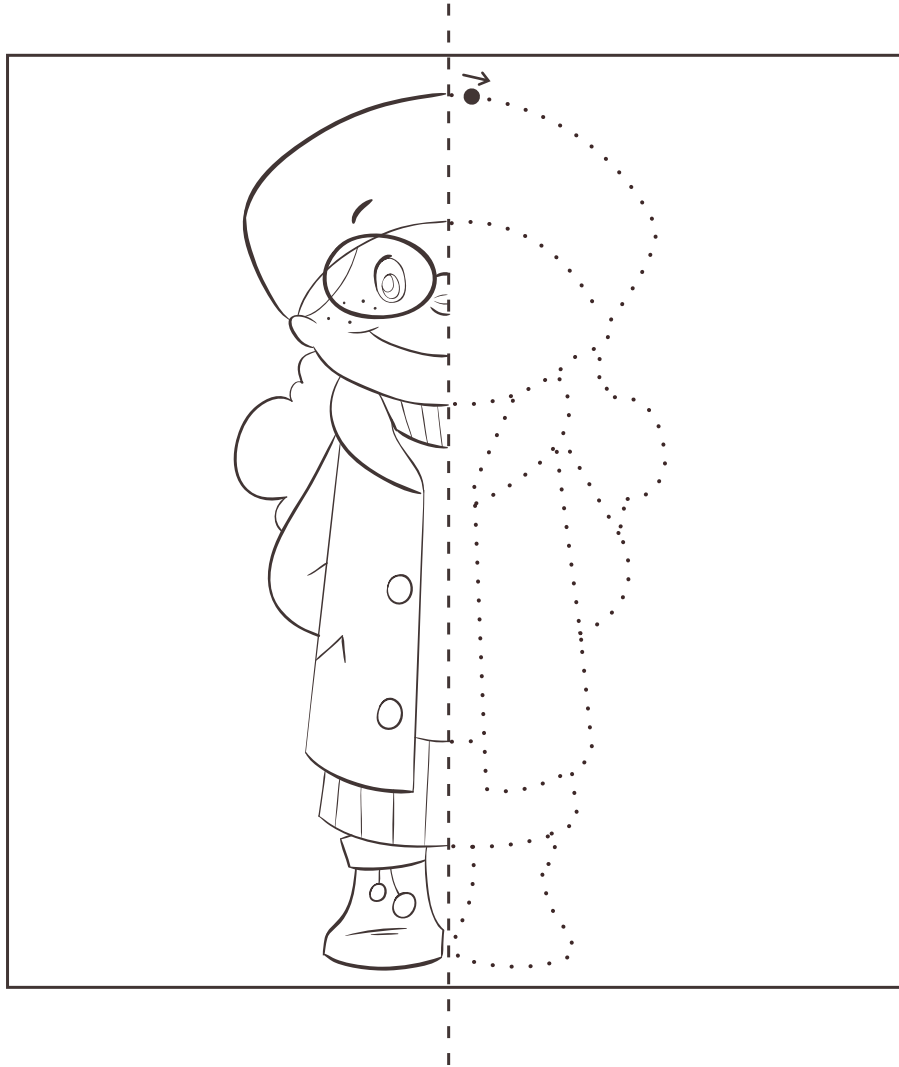

■ Put on / Take off your (hat). (boots, coat, jumper, dress, trousers)



Cut and stick.

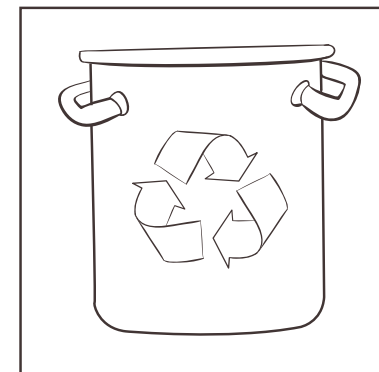
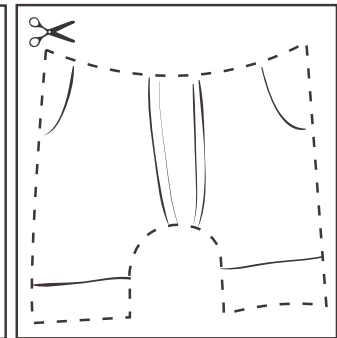
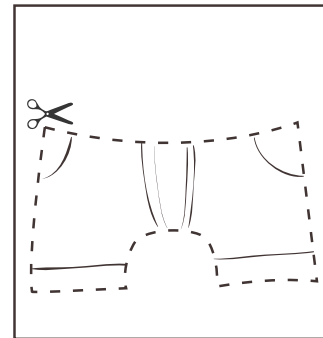
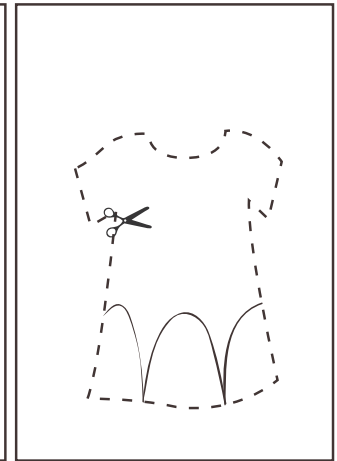
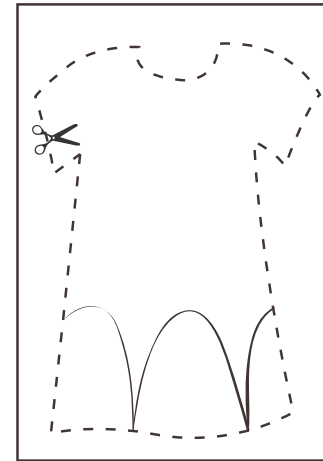
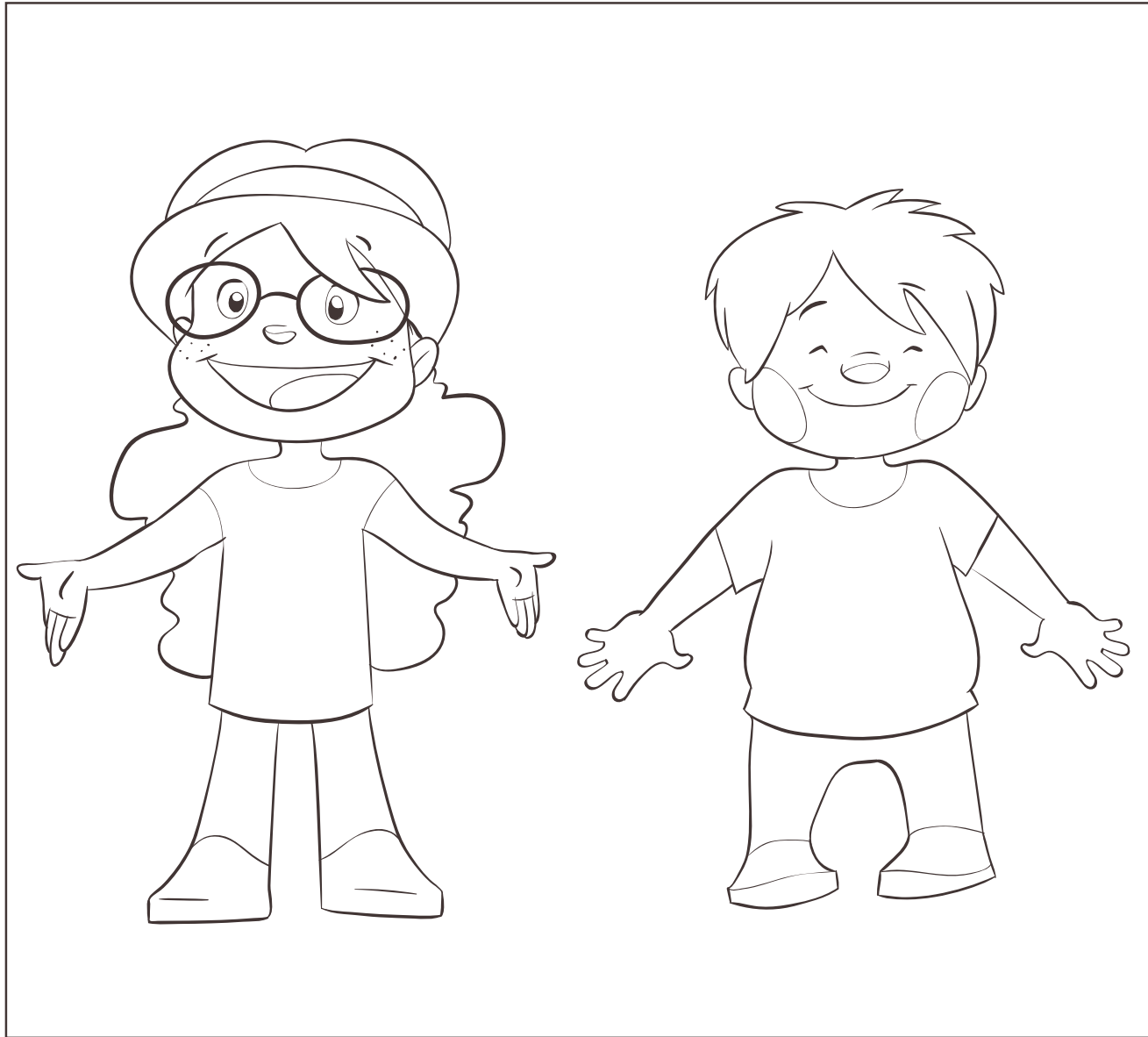

Look and draw.

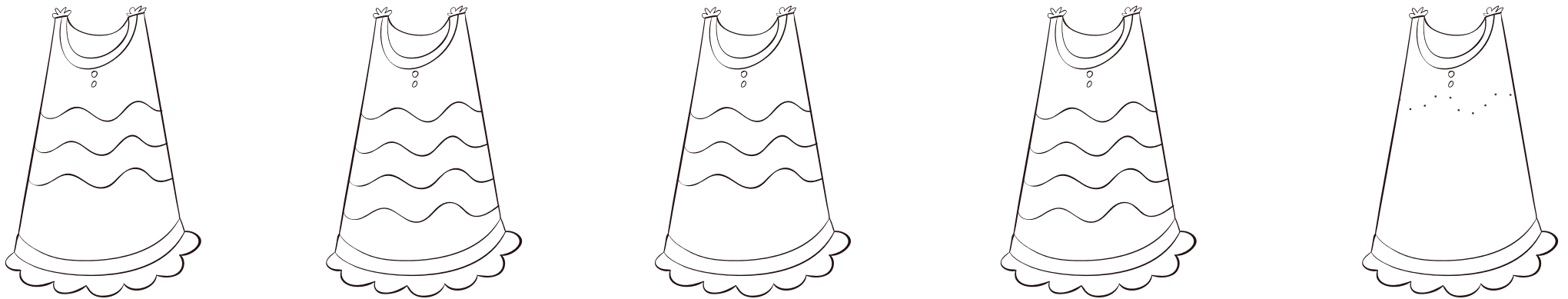
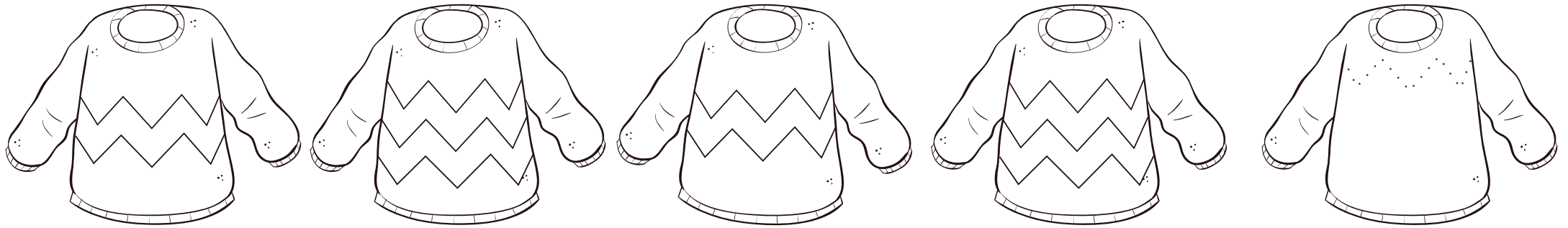



Make a Phonics book.

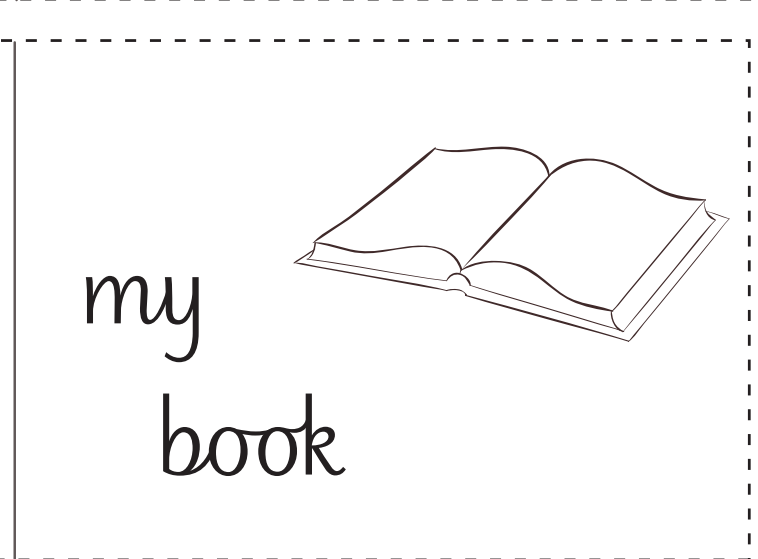
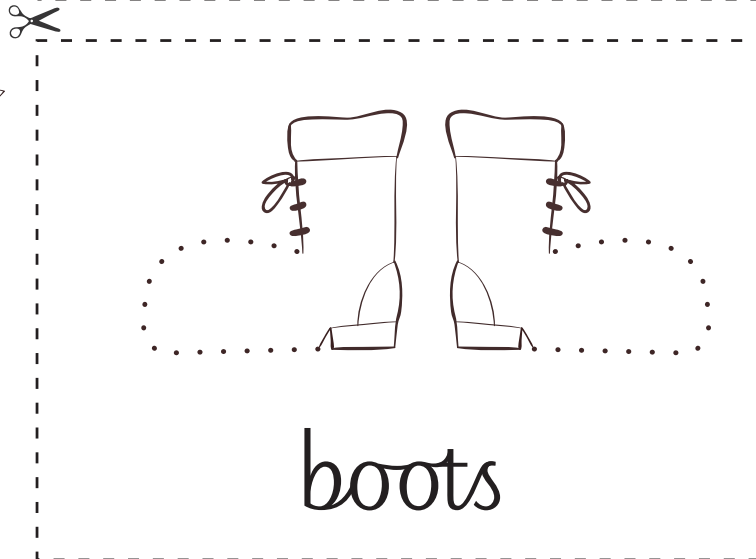
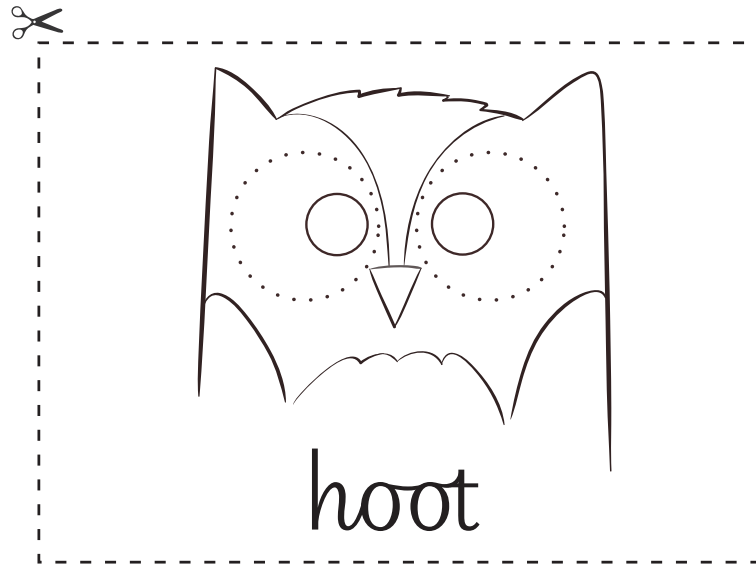
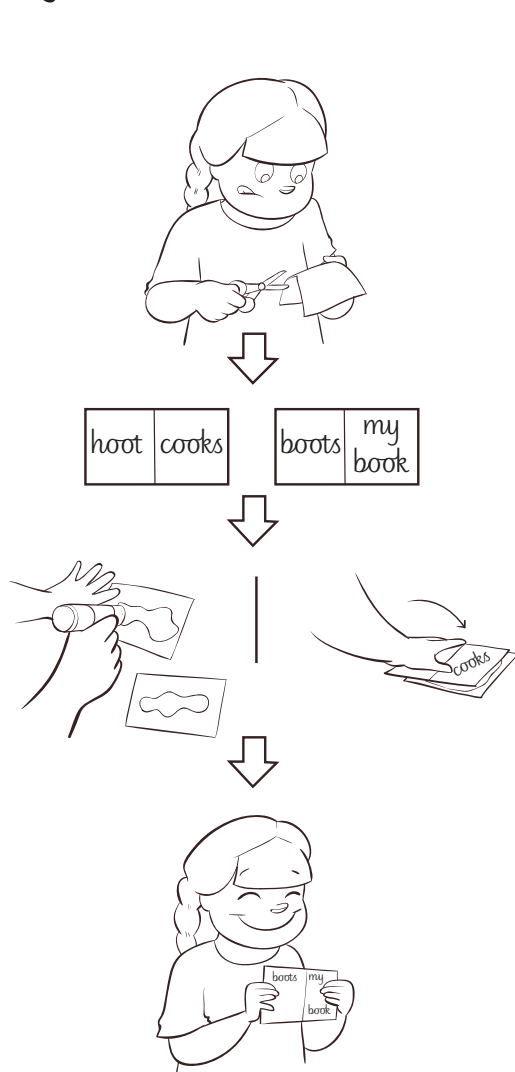



Winter Fun!

Winter project: Paint, cut and stick to make a winter scene.

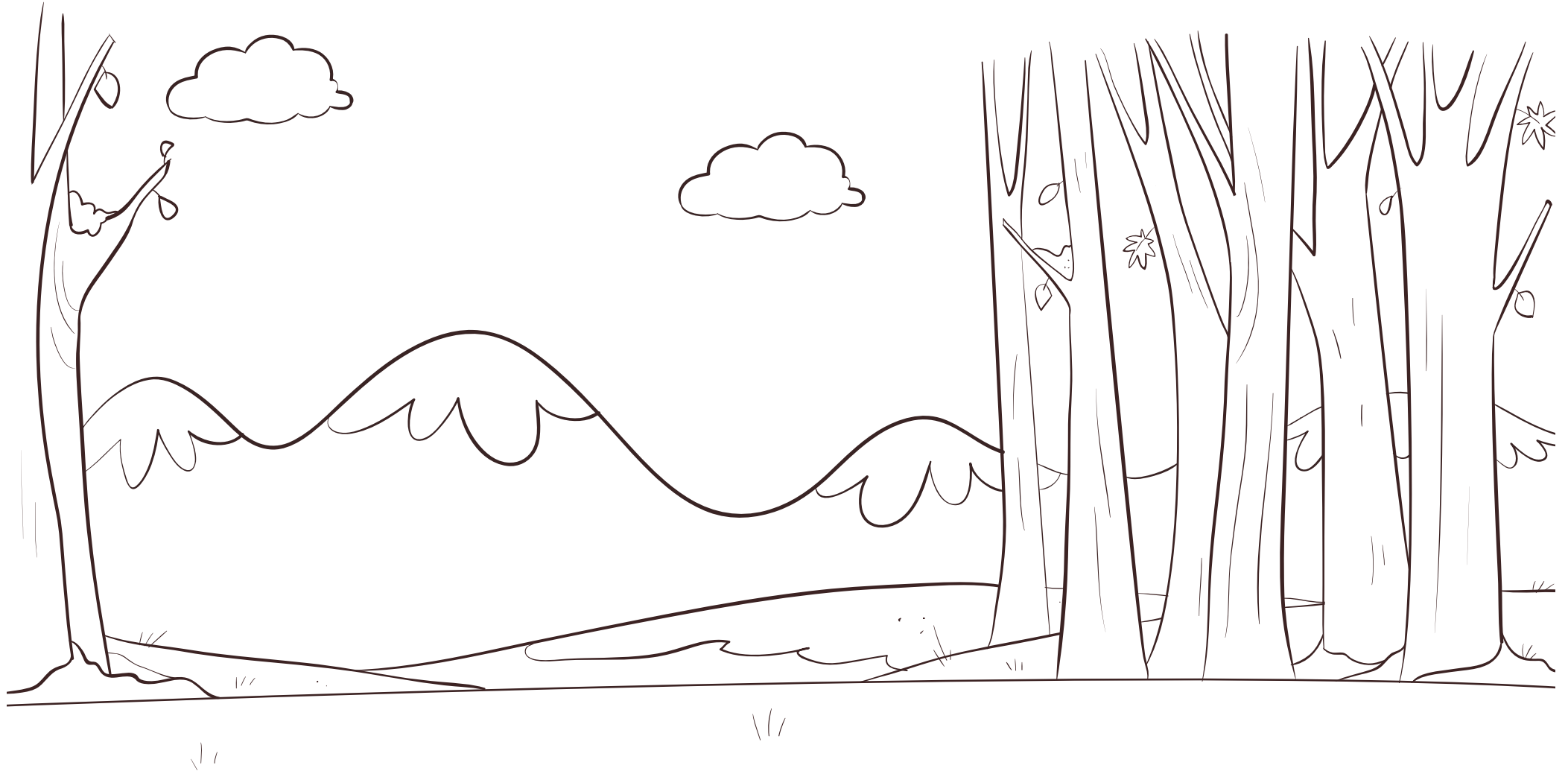

Winter project: Paint, cut and stick to make a winter scene.

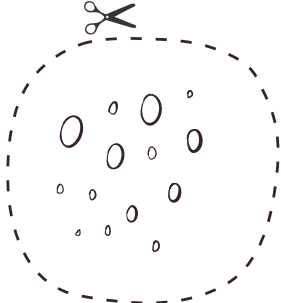
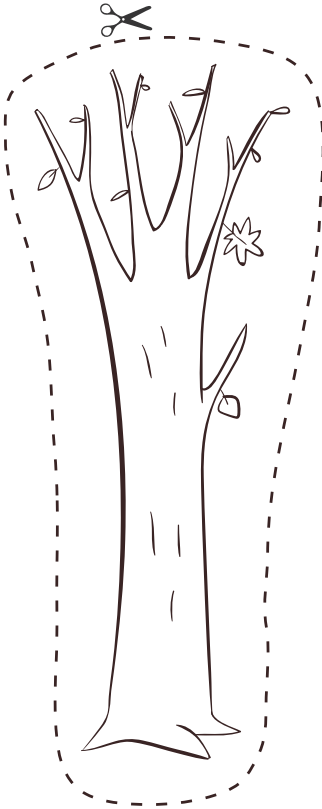
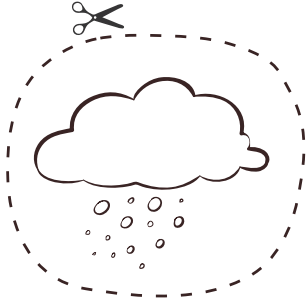

5 Can I Help You?

Cut and match.

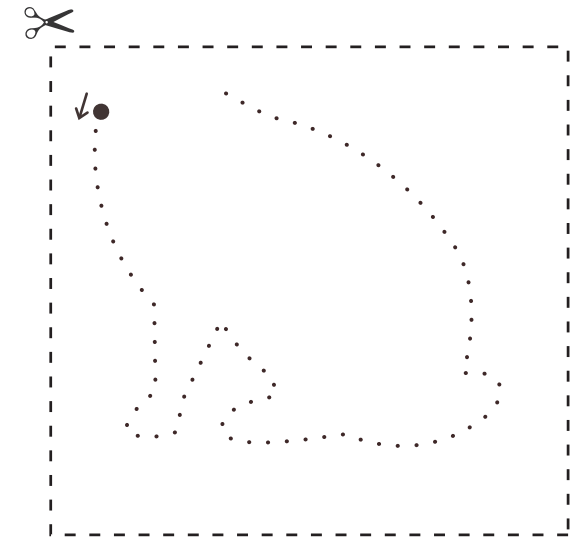
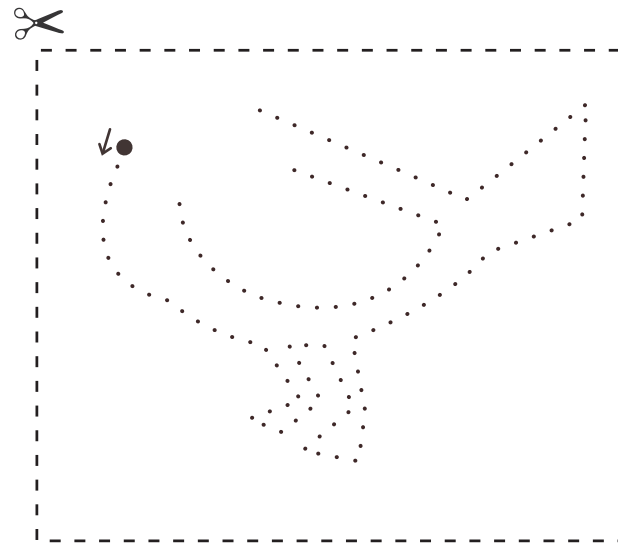
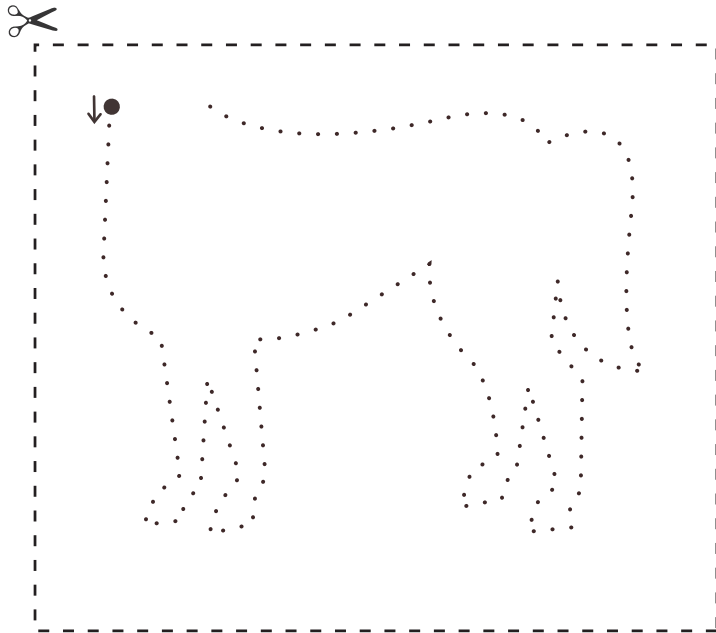
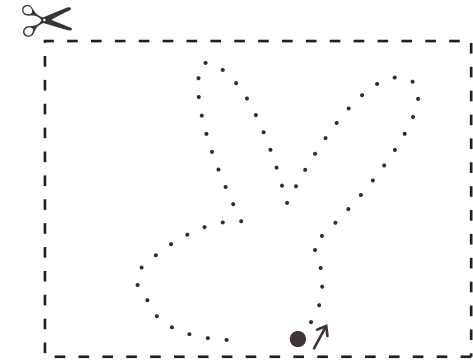
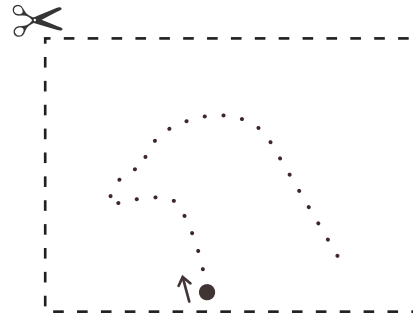
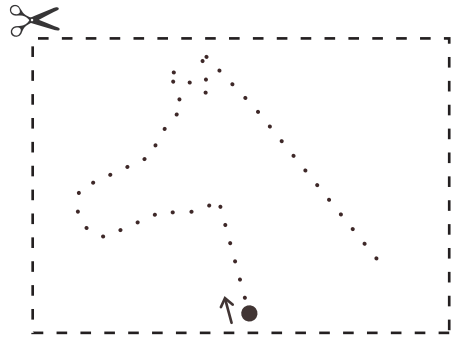

■ Have you got strong (arms)? (cow, horse, sheep, hen, pig, rabbit)

Circle the strong one.

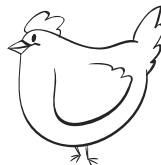
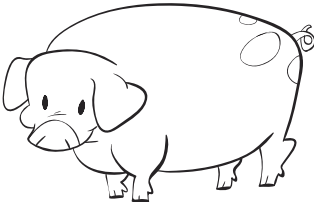
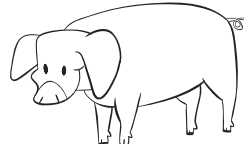
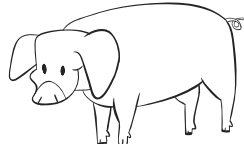
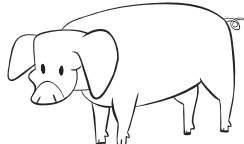
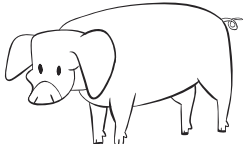
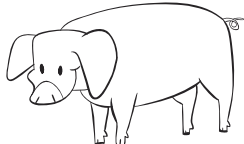
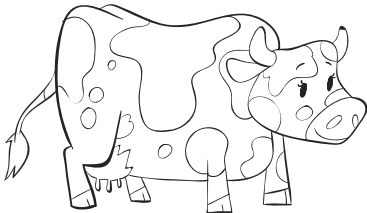
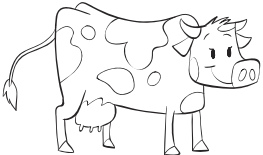
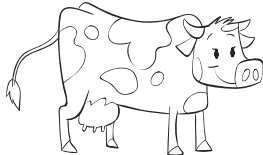
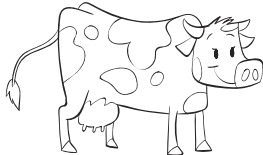
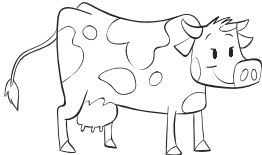
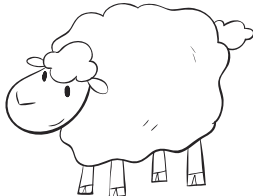
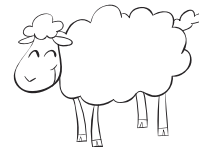
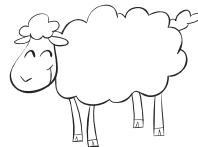
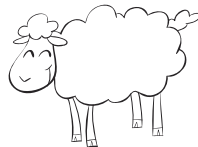
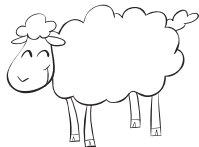

Trace Hedgehog.

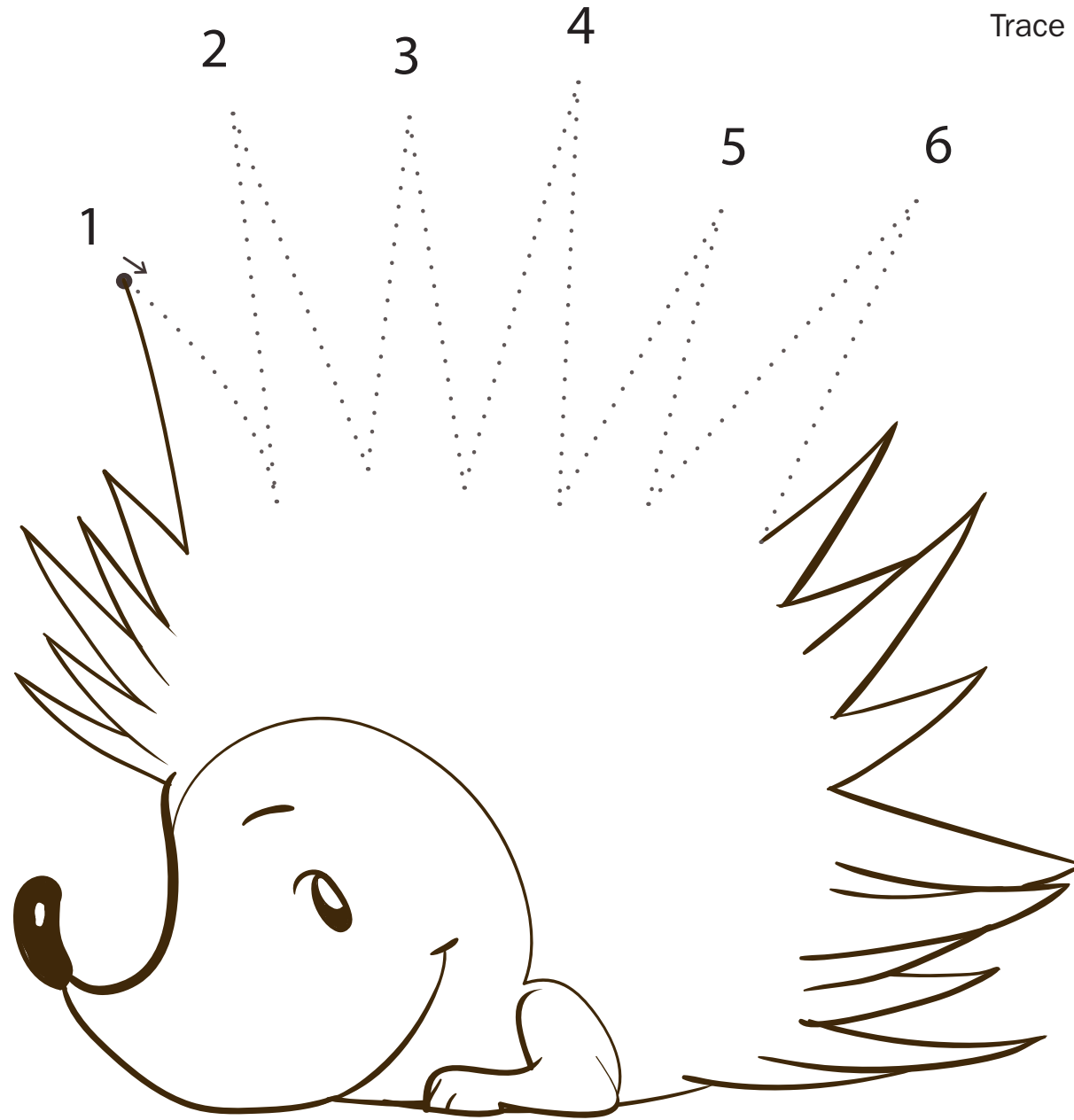



Make Phonics cards.

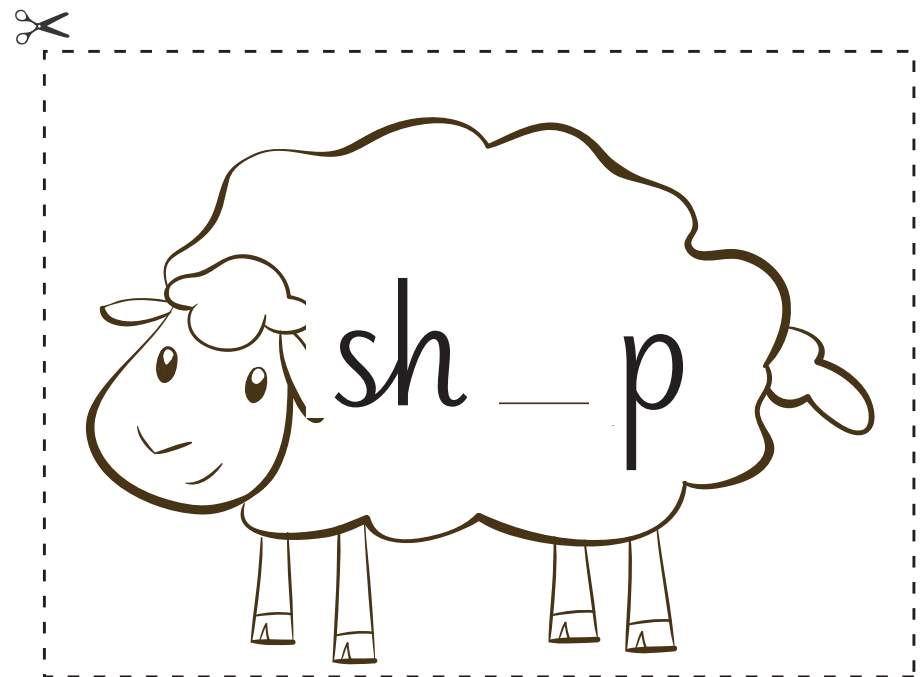
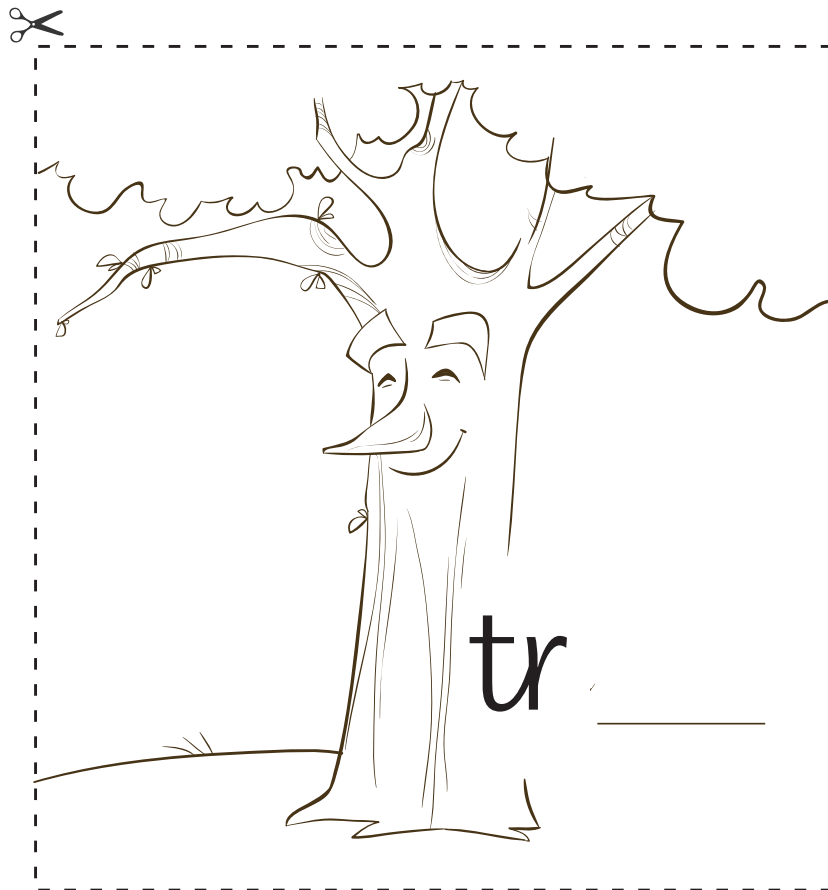
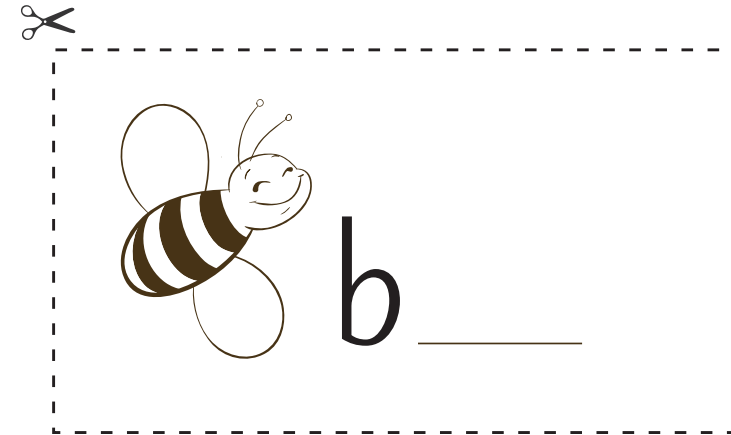

6 The Summer Party

Make a food wheel.

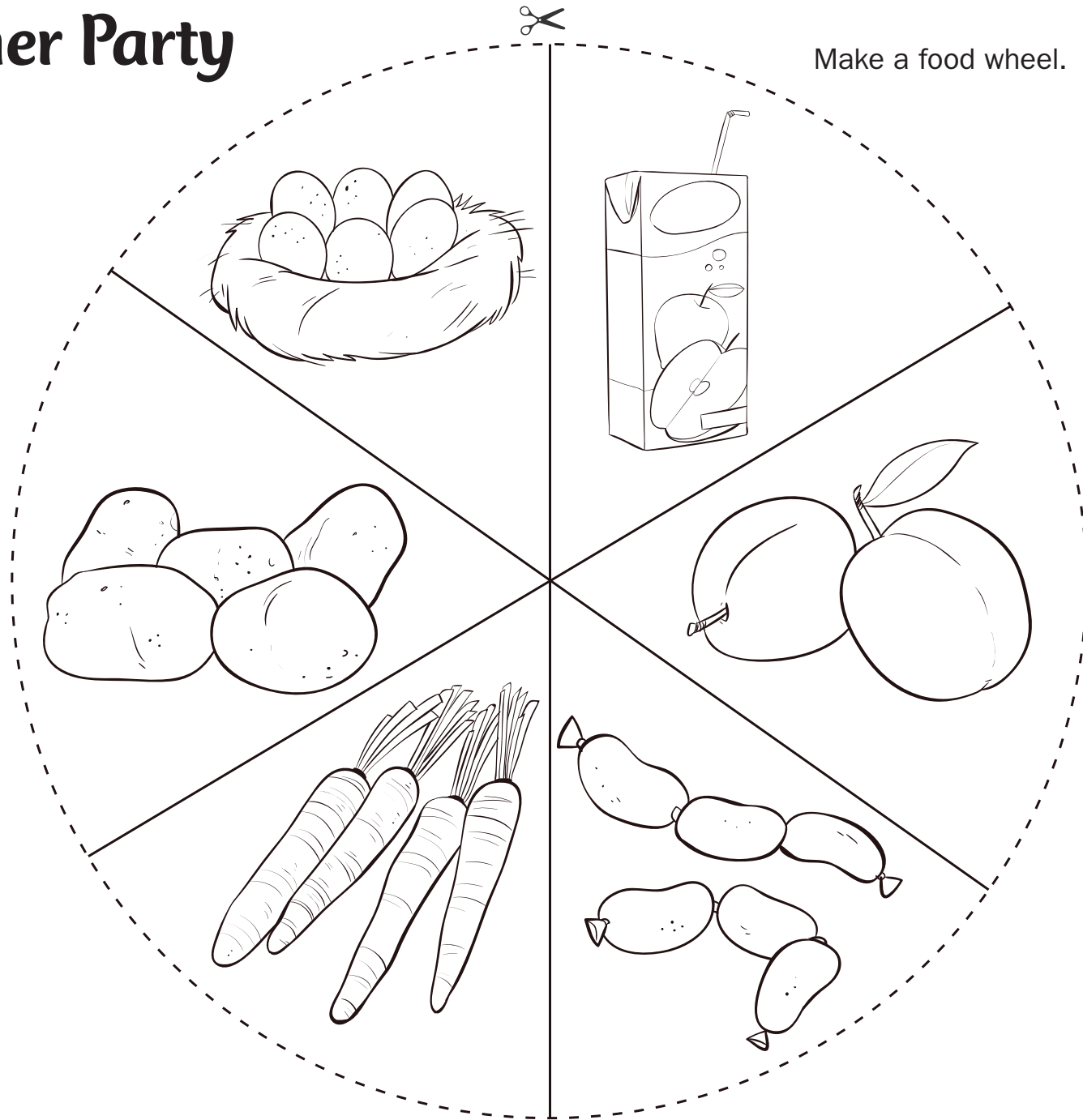

Have you got any (carrots)? / Can I have some (juice)? (egg, potato, sausage, plum)

Look and circle.

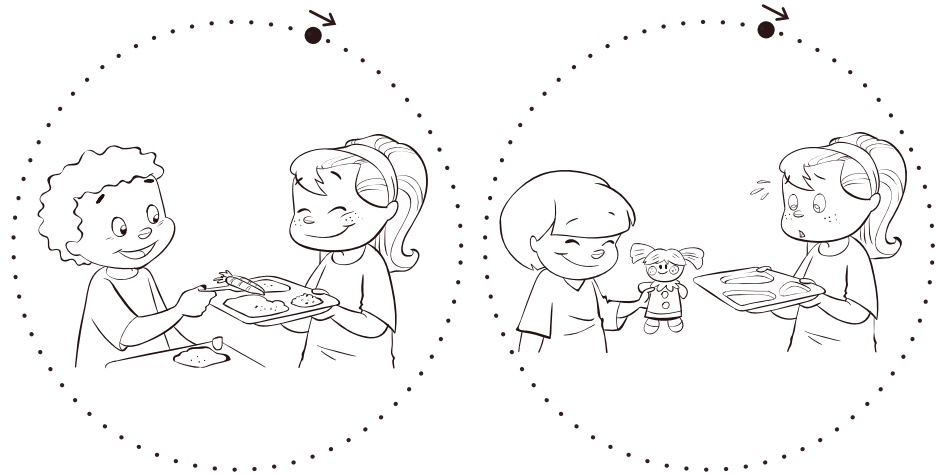
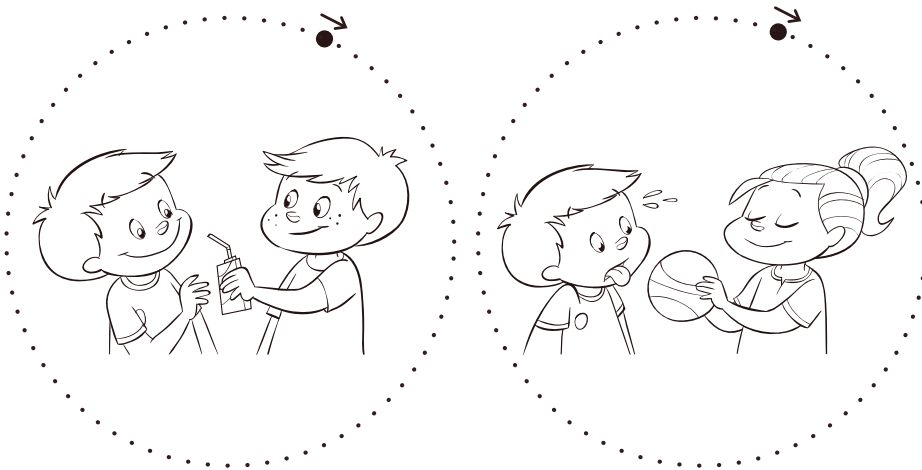
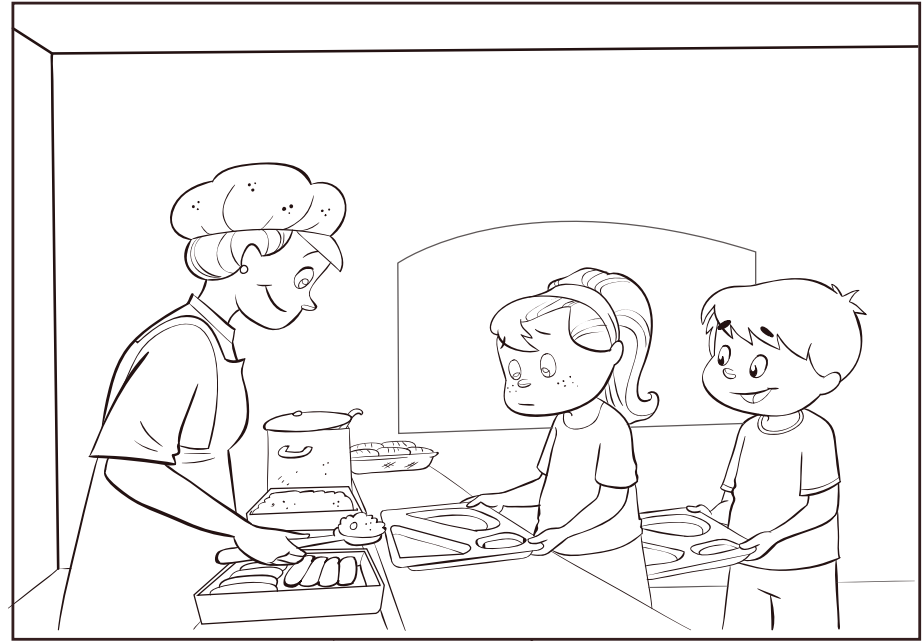
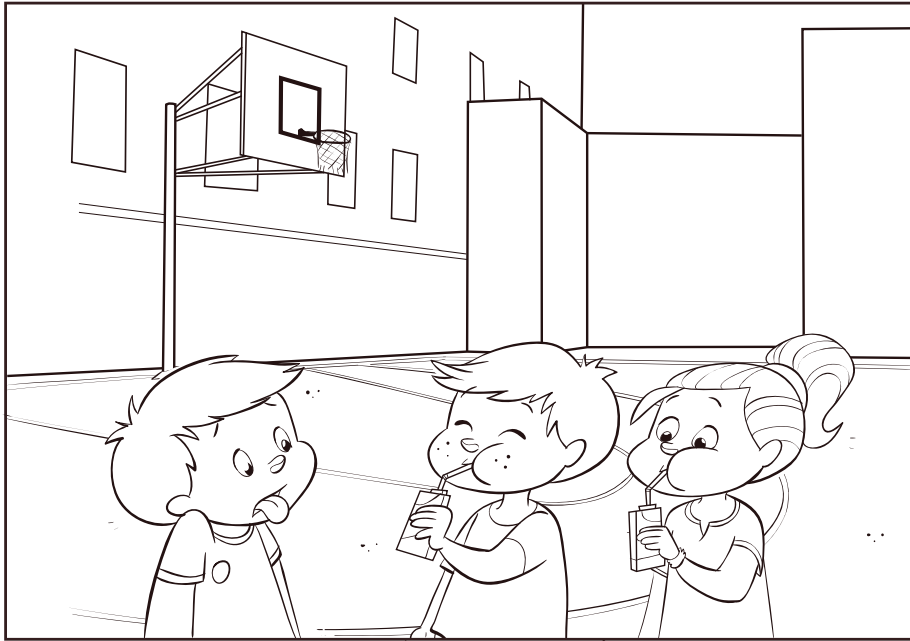

Listen and colour. Then colour by number.



1 ○

2 ○

3 ○

4 ○

5 ○

6 ○

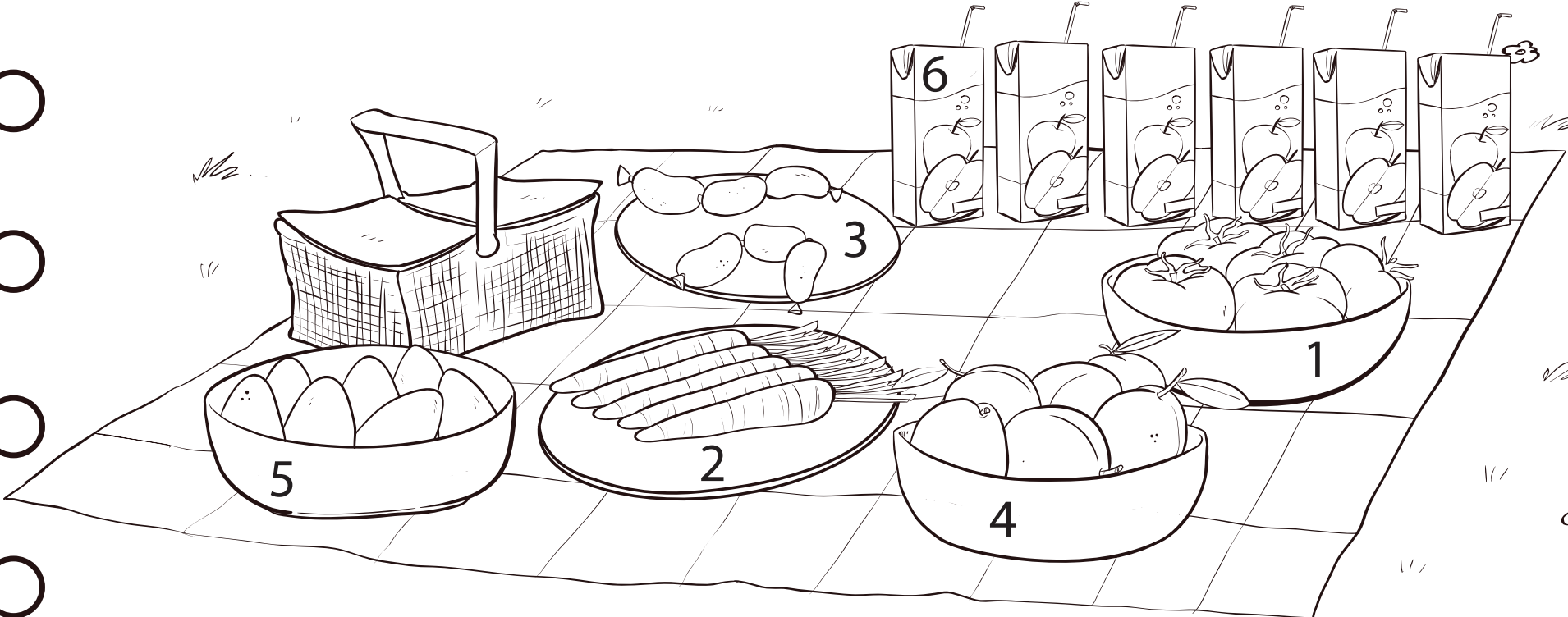



Complete the words using the Phonics cards.

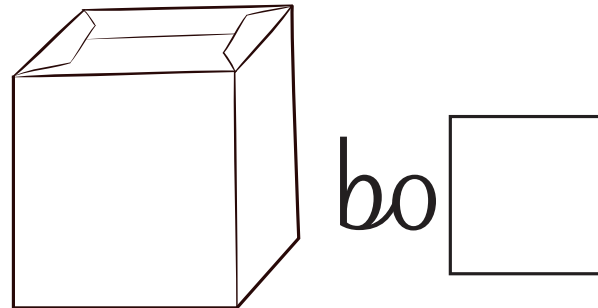
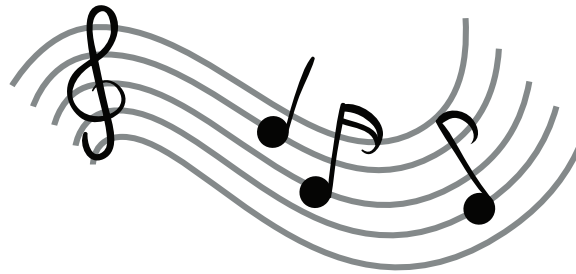
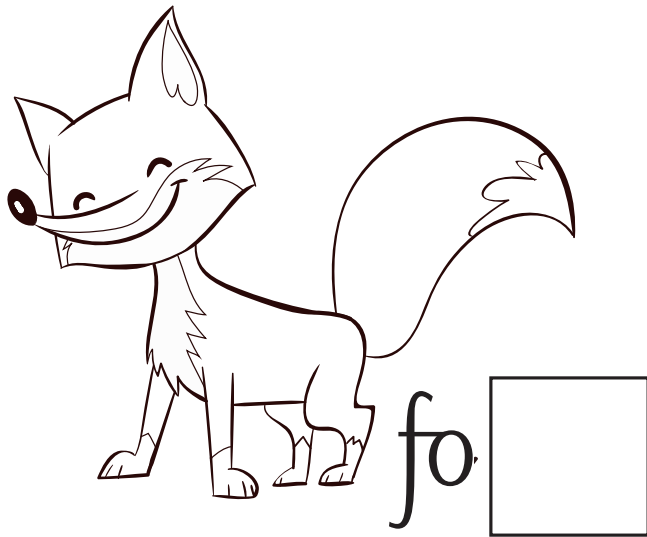
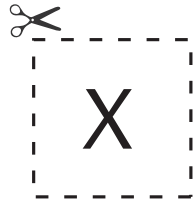
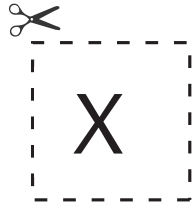



Spring Fun!

Spring project: Paint, cut and stick to make a spring string.

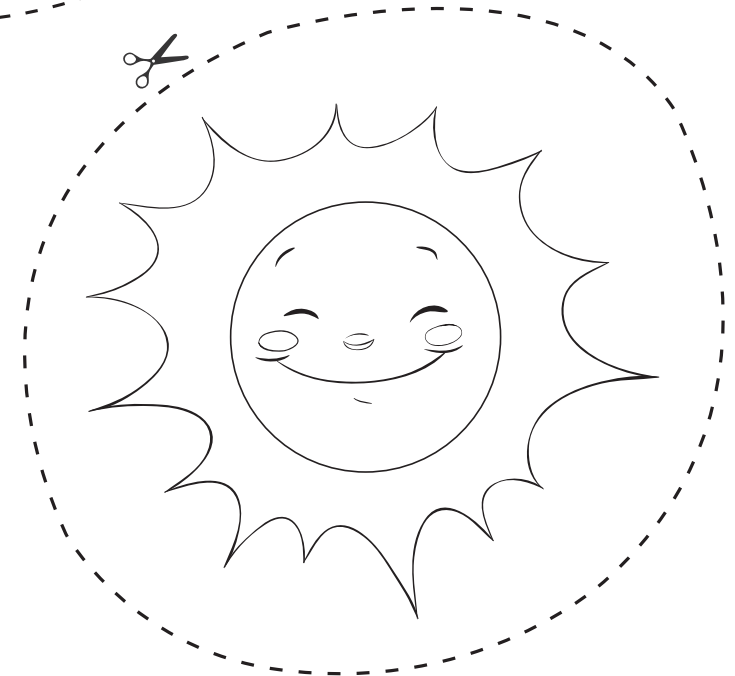
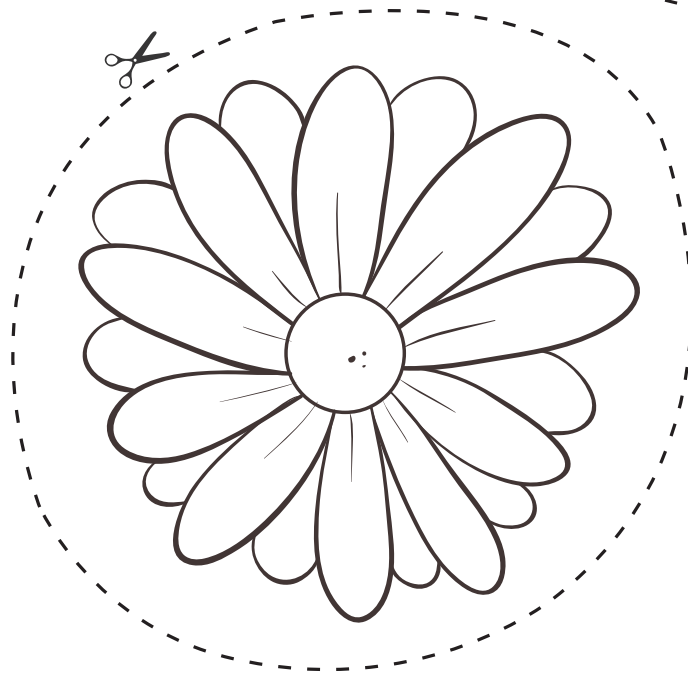
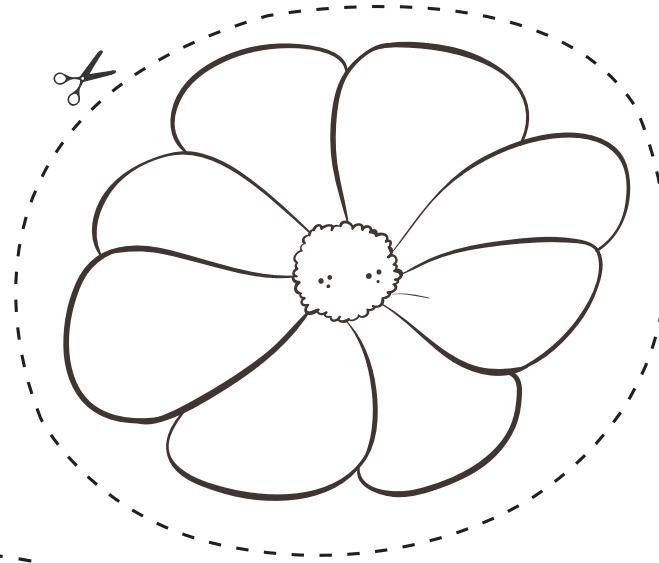

Spring project: Paint, cut and stick to make a spring string.

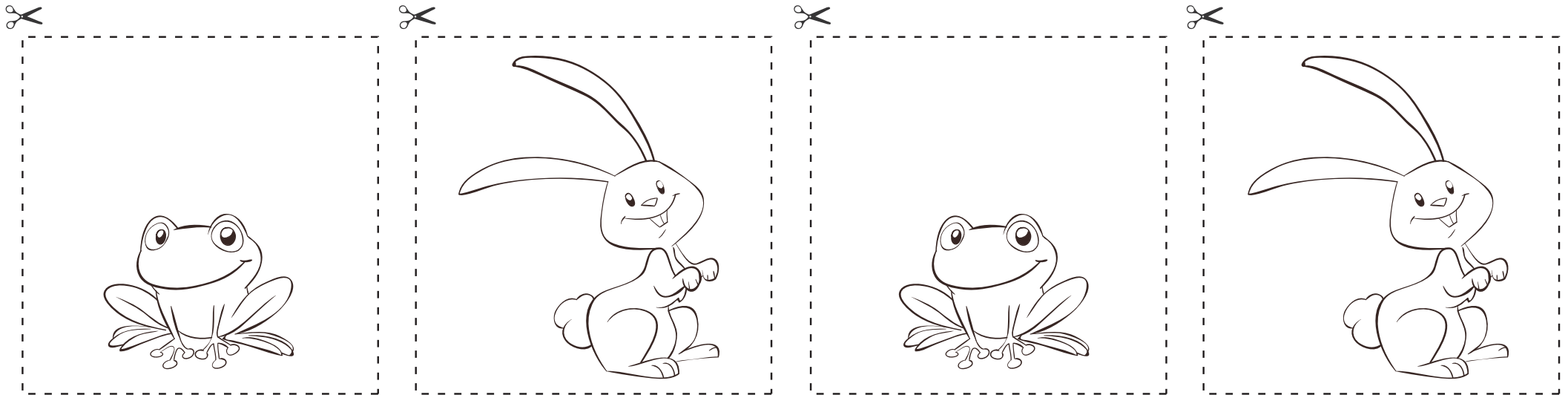



Summer Fun!

Summer project: Paint, cut and stick to make a swimming pool scene.

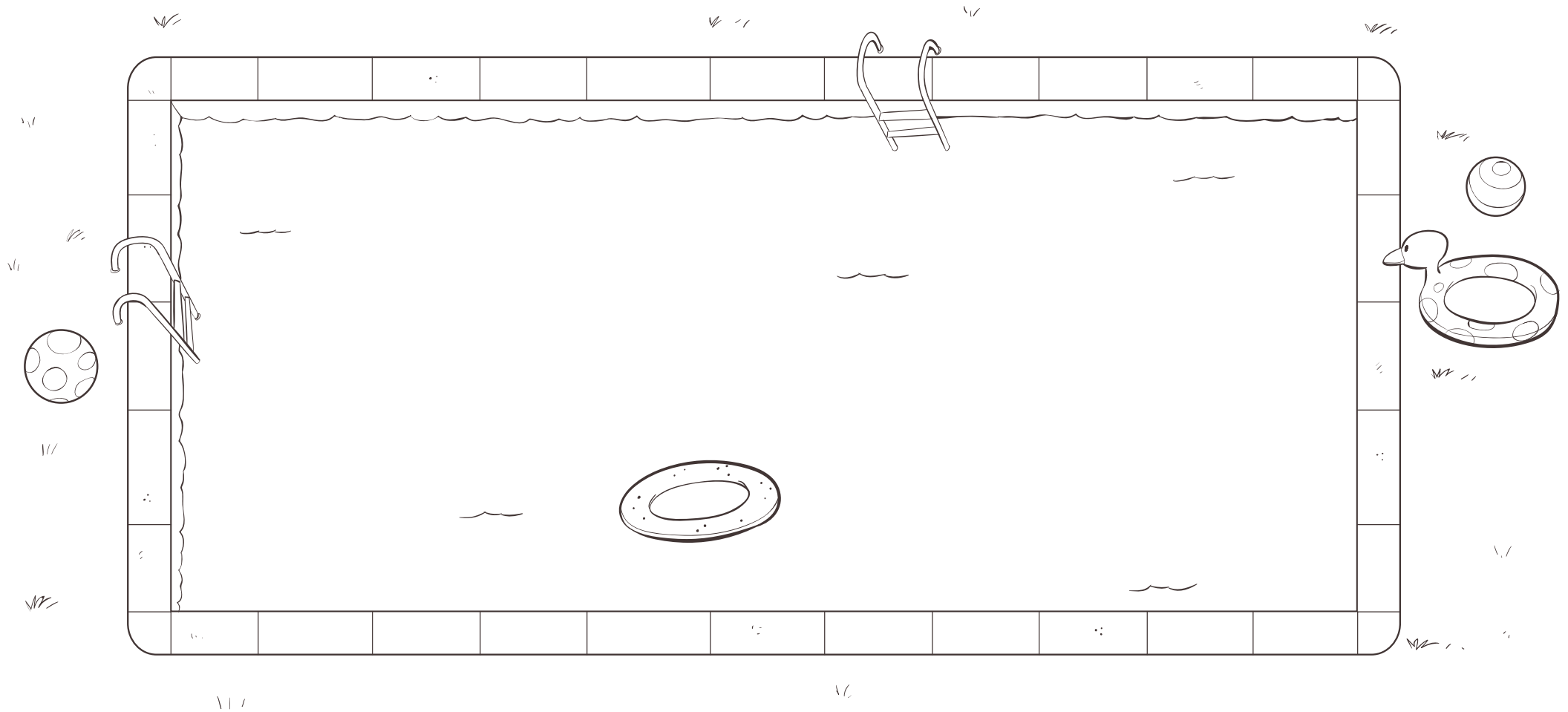

Summer project: Paint, cut and stick to make a swimming pool scene.

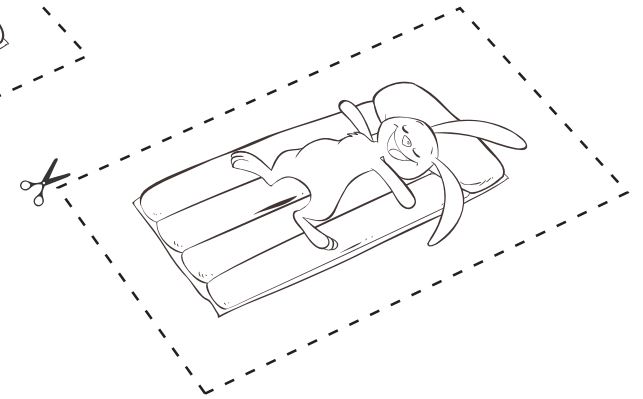
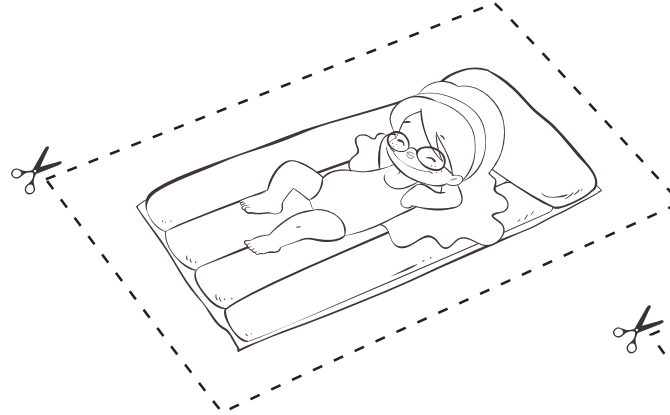
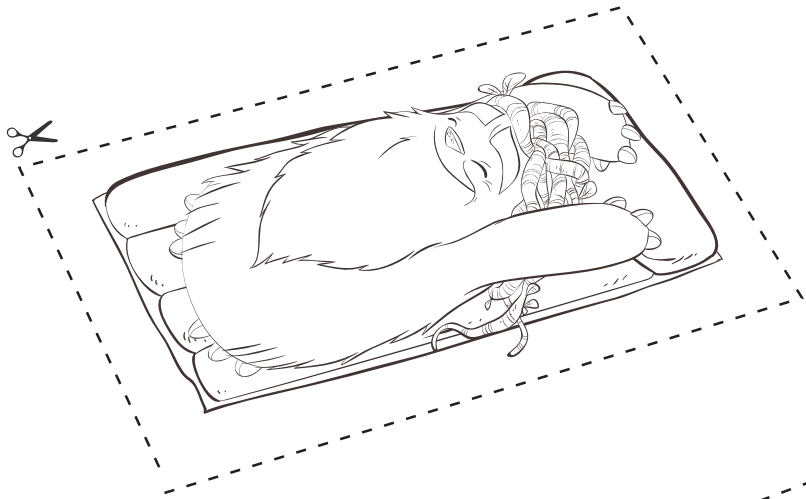



Congratulations!

Name _____





Halloween

Trace and color the bat.

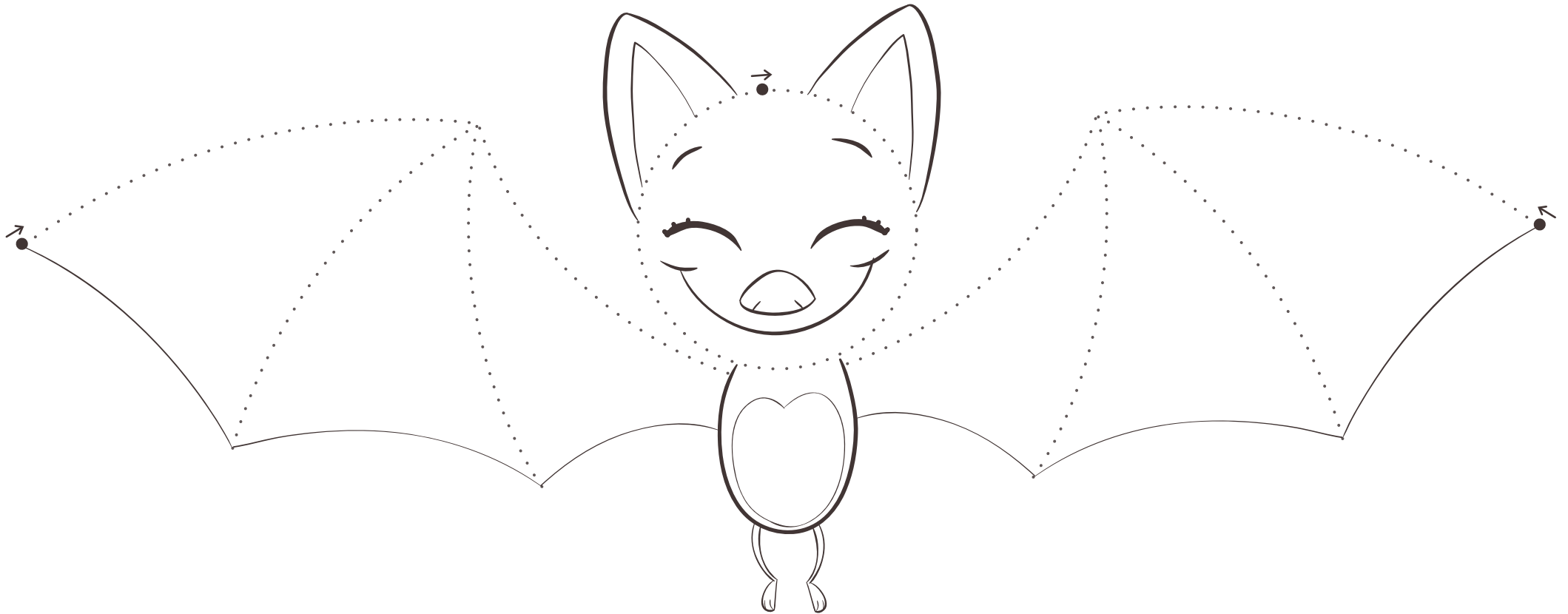



Cut out and play.

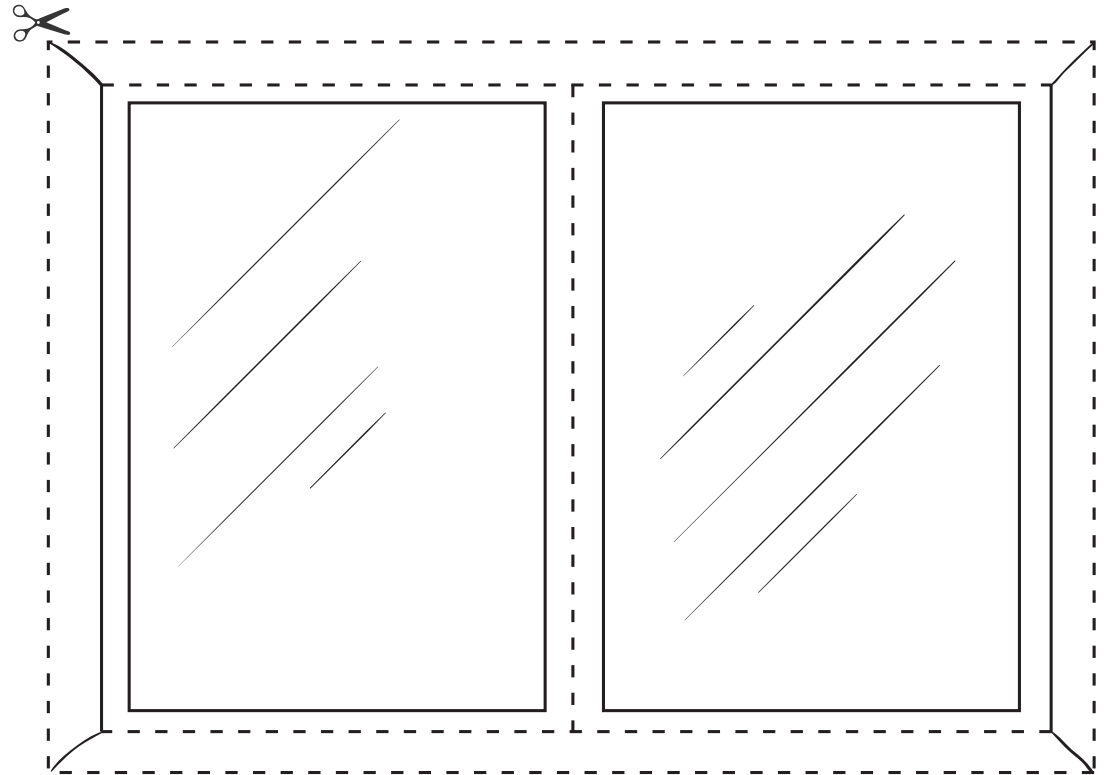
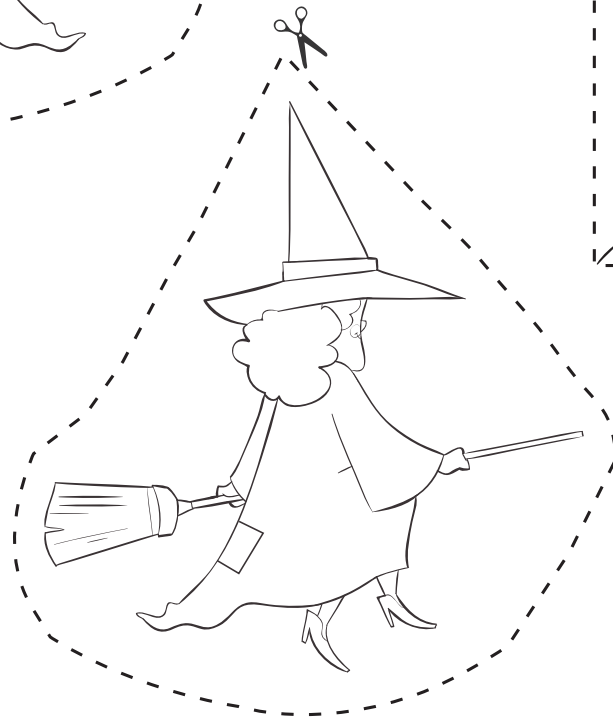



Christmas

Trace and colour the Christmas tree.

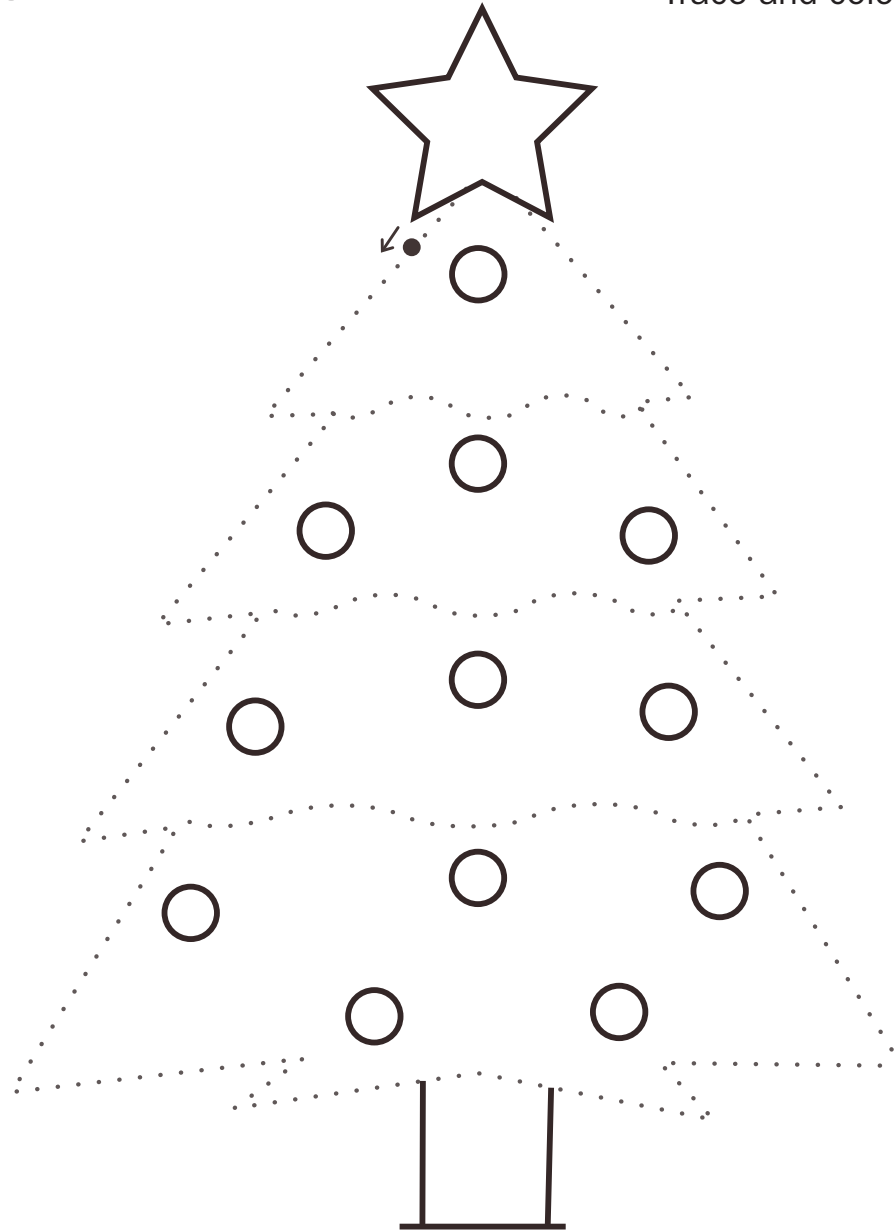



Cut out, colour and sing the Phonics Christmas song.

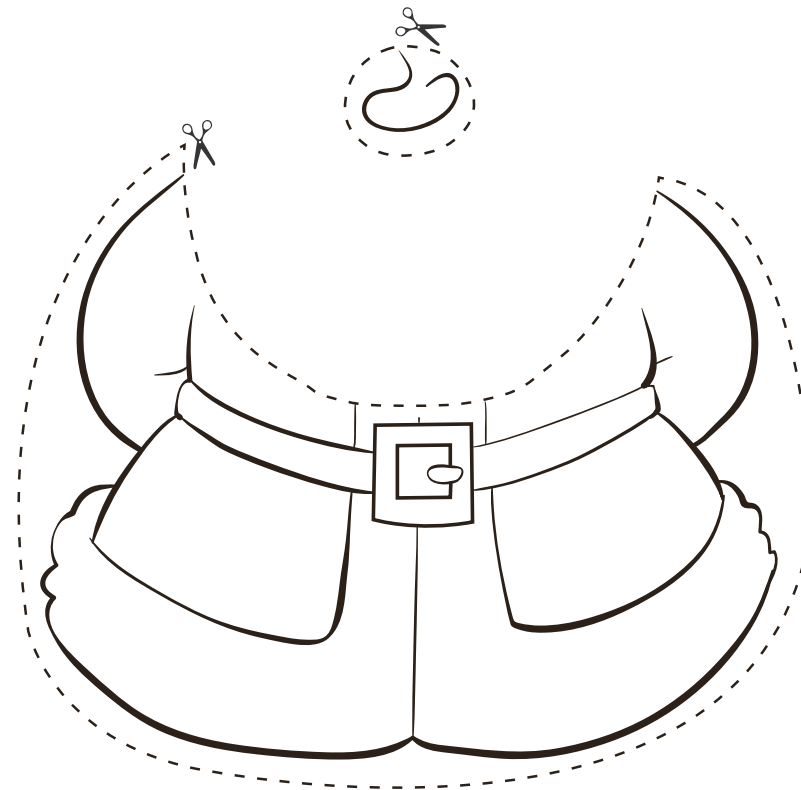
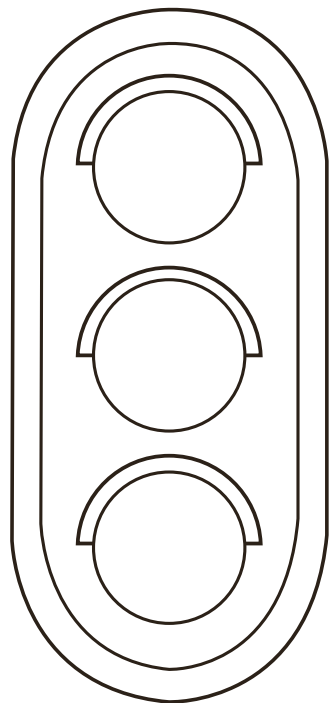



Easter

Trace and colour the basket.

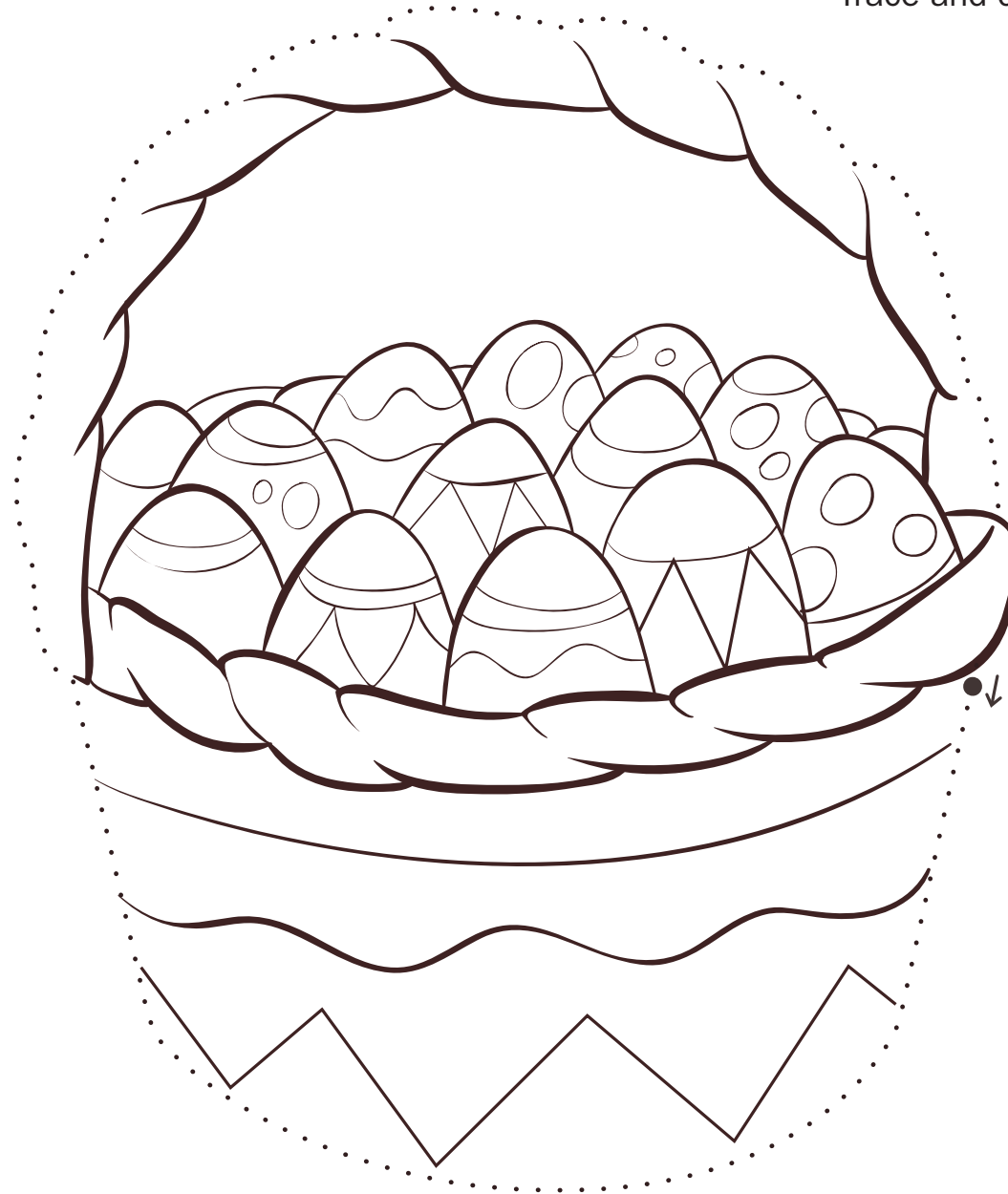



Colour and cut out the chick and the egg. Then sing the Phonics Easter song.

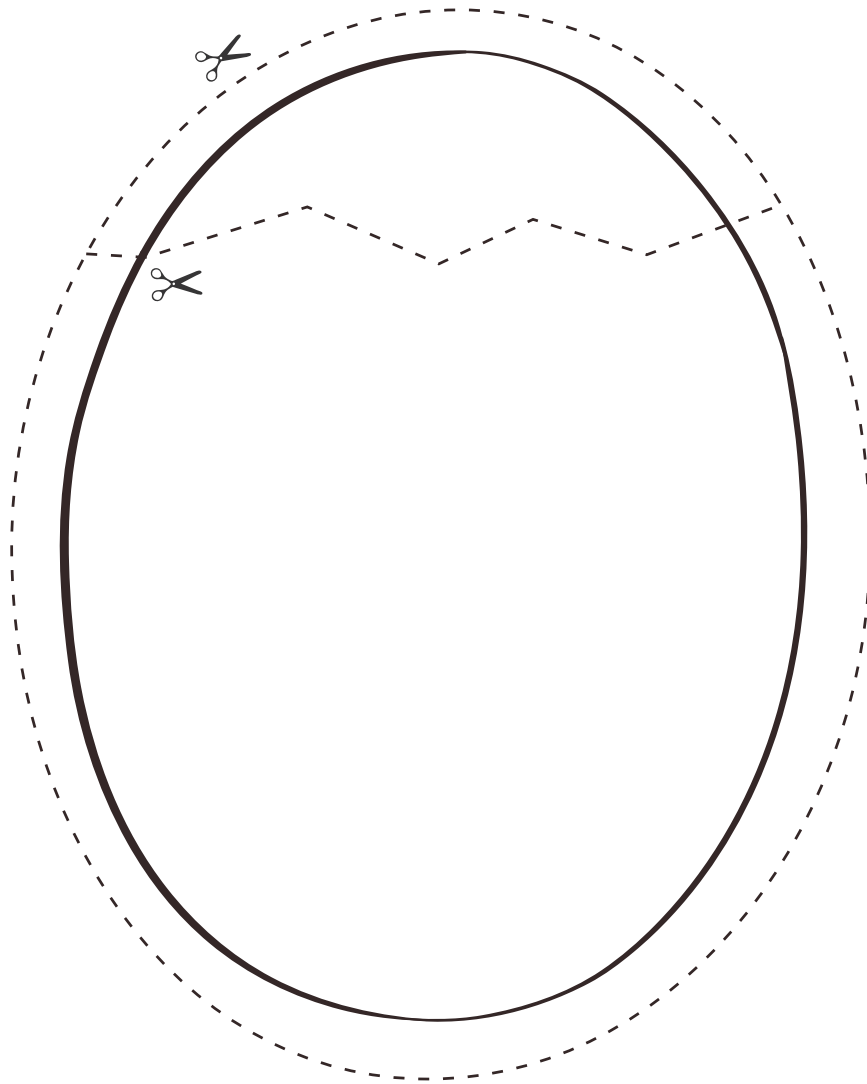



Green Day

Help Sam and Nico recycle the rubbish.

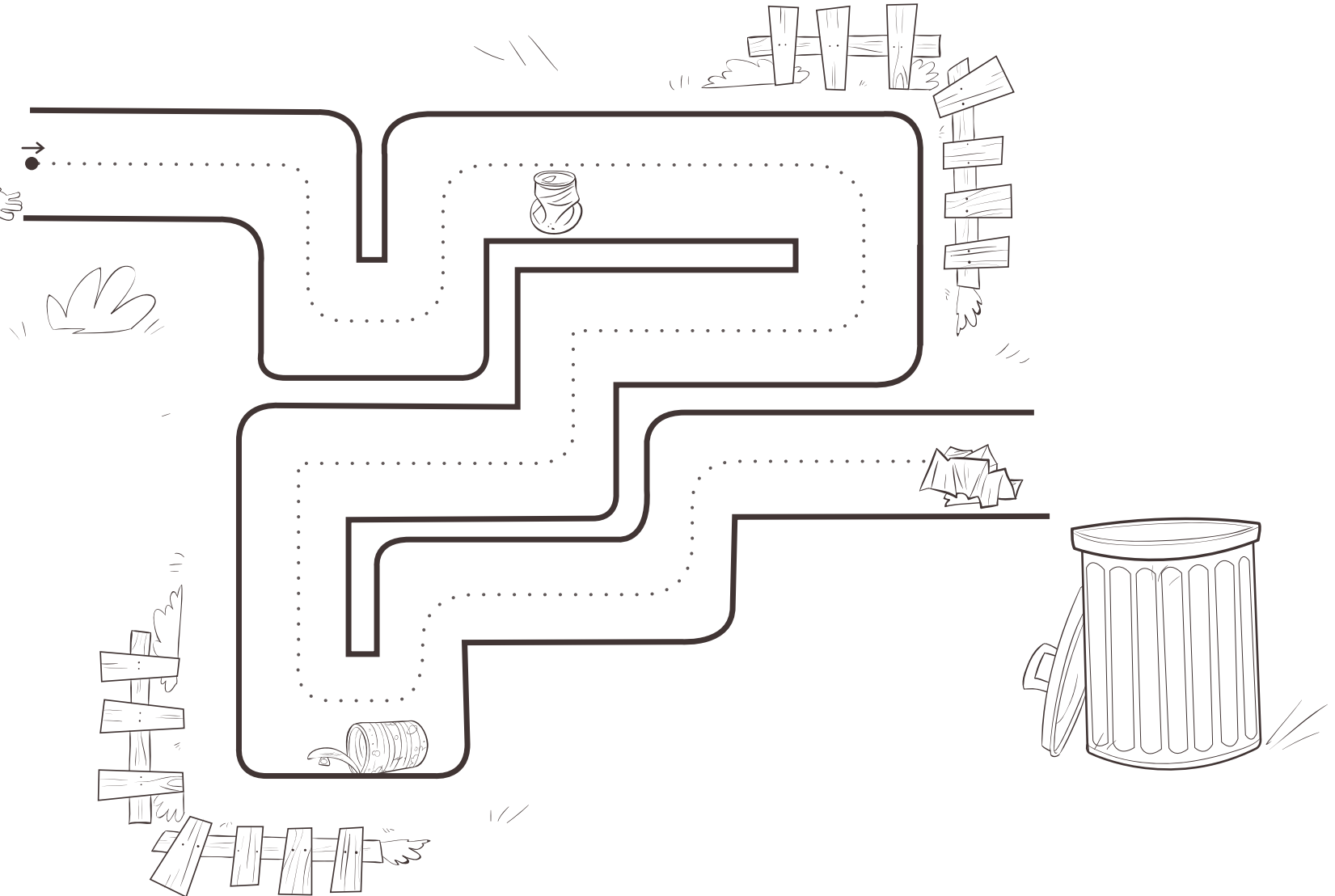



Make a rainy day puzzle.

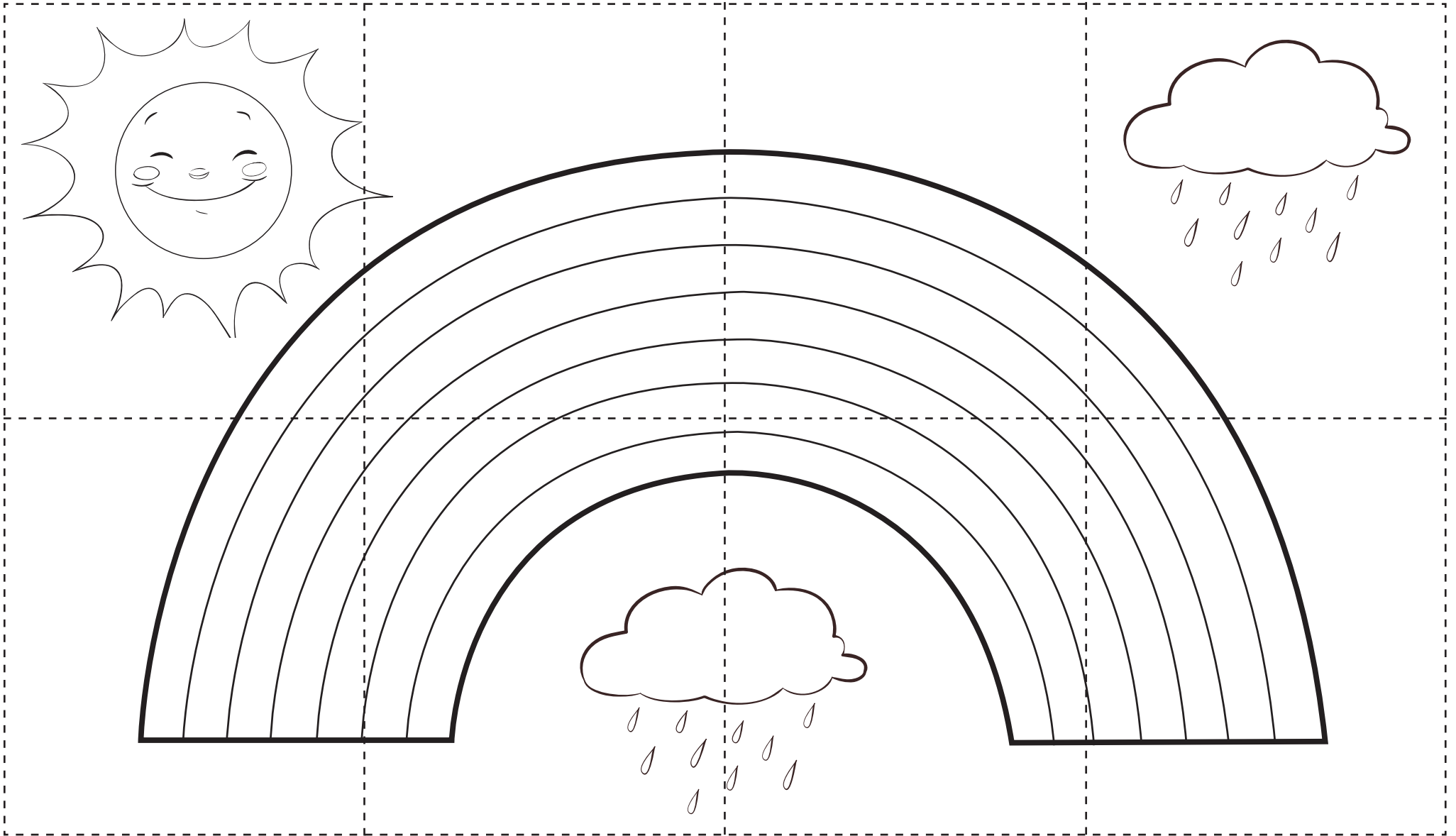

Goodbye!



Goodbye!



Goodbye!



CAMBRIDGE
UNIVERSITY PRESS

c/ Orense, 4 - 13º, 28020 Madrid, Spain

Cambridge University Press is part of the University of Cambridge.

It furthers the University's mission by disseminating knowledge in the pursuit of education, learning and research at the highest international levels of excellence.

www.cambridge.org

© Cambridge University Press 2015

This publication is in copyright. Subject to statutory exception and to the provisions of relevant collective licensing agreements, no reproduction of any part may take place without the written permission of Cambridge University Press.

First published 2015

Printed in Spain

Legal deposit: M-3621-2015

ISBN 978-84-9036-829-9	Teacher's Resource Book A
ISBN 978-84-9036-826-8	Big Book A
ISBN 978-84-9036-825-1	Pupil's Book A (with Stickers and Pop-outs)
ISBN 978-84-9036-827-5	Teacher's Book A
ISBN 978-84-9036-828-2	Guía Didáctica A
ISBN 978-84-9036-831-2	Flashcards A
ISBN 978-84-9036-830-5	Phonics Flashcards A
ISBN 978-84-9036-832-9	Class Audio CDs A
ISBN 978-84-9036-833-6	Digital Forest A
ISBN 978-84-9036-845-9	Routine Board
ISBN 978-84-9036-000-2	Reward Stickers
ISBN 978-84-9036-001-9	Reward Stamp
ISBN 978-84-9036-846-6	Teacher's Bag
ISBN 978-84-9036-844-2	Puppet

Cambridge University Press has no responsibility for the persistence or accuracy of URLs for external or third-party Internet websites referred to in this publication, and does not guarantee that any content on such websites is, or will remain, accurate or appropriate.

Thanks and Acknowledgements

Author's thanks

Marilyn Miller would like to thank everyone at Cambridge University Press. In particular, to Jeannine Bogaard and Julieta Hernández for providing me with the opportunity to write, and to Mercedes Lopez de Bergara for her continued support.

Karen Elliott would like to thank everyone at Cambridge University Press and in particular Mercedes López de Bergara for her enthusiasm and dedication to the phonics section of the project; Mary Ockenden at the American School Bilbao, Aitziber Gutiérrez and Piluca Baselga at the Colegio Infantil Haurbaki for their help and suggestions on phonics at various stages of the project.

A special thank you goes to Juan González Cué, our Production Project Manager.

The authors and publishers are grateful to the following illustrators:

Gema García Ingelmo: cover illustration and characters concept

Antonio Cuesta Cornejo: illustration

The publishers are grateful to the following contributors:

Teresa del Arco: layout and design

Chefer: cover design

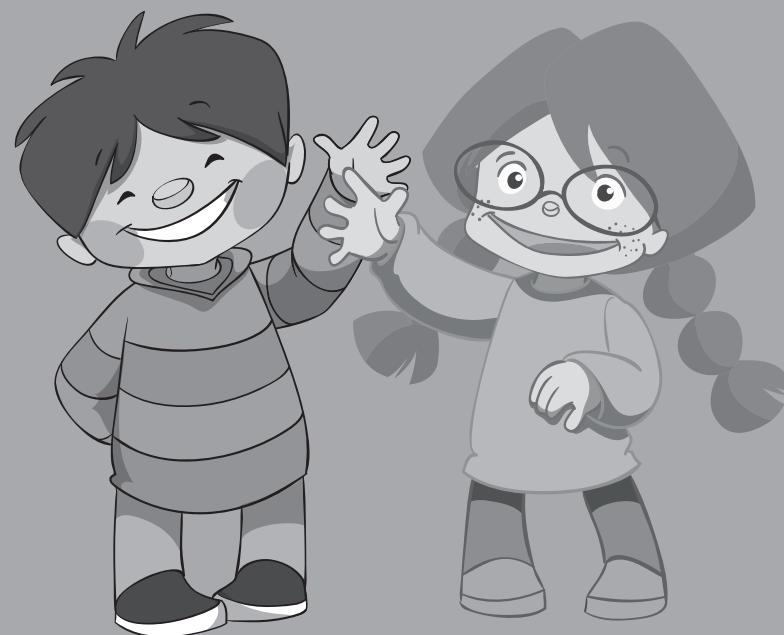

www.greenmanandthemagicforest.es

▶ GREENMAN & THE MAGIC FOREST STARTER
GREENMAN & THE MAGIC FOREST A
GREENMAN & THE MAGIC FOREST B



CAMBRIDGE
UNIVERSITY PRESS
www.cambridge.org

ISBN 978-84-9036-829-9

